



2026 US & CANADA
WATER FEATURES
CATALOG

*"This
is the
life."*

Your Paradise. Our Passion.®

aquascapeinc.com

We connect people to water the way nature intended.

At Aquascape, we connect people to water the way nature intended. Our patented ecosystem approach – combining circulation, filtration, plants, fish, rocks, and gravel – creates water features that are both beautiful and naturally sustainable.

In this catalog, you'll find our proven lineup of pumps, filters, complete water feature kits, fish and plant care, along with exciting new products for 2026. Explore our newly redesigned wetland filtration offerings, fountain covers in new sizes, and the impressive Large Fountain Light.

As the only water feature manufacturer in the world that designs, builds, and maintains ponds every day with our own crews, we know what works – because we use it ourselves.

Stay inspired by following our inspiring projects and adventures on social media, where we share endless ideas, innovation, and creativity from the world of water. Dive in – your next great project starts here!

– Greg Wittstock , *The Pond Guy*
Founder and CEO Aquascape, Inc.

Greg Wittstock
The Pond Guy



When it comes to building work-of-art, one-of-a kind, custom creations, we don't create with canvas, acrylics, or a paint brush. We use rock, gravel, and water.

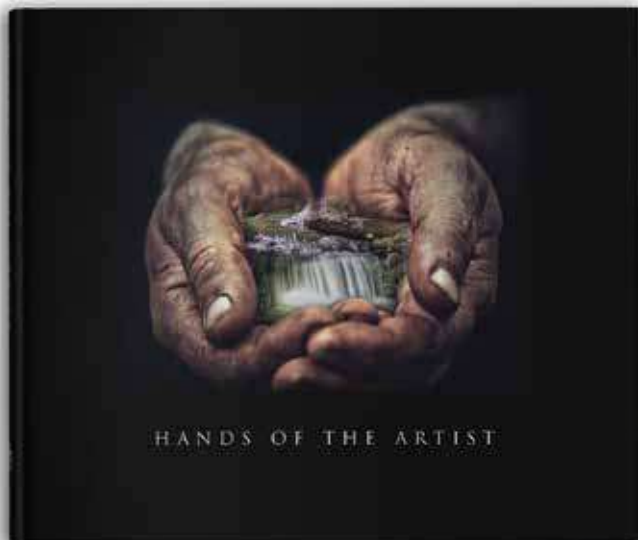

Full-Color, Hardcover Coffee Table Book
Hands of the Artist won't disappoint. Page-by-page and build-by-build, you'll be mesmerized by the stunning artistry of our work.



Aquascape Hands of the Artist V6

Packaged Weight: 4 lb.

Packaged Dimensions: 11.25" L x 10.25" W x 1" H

#86457

Table of Contents



Living the Aquascape Lifestyle®

Our passion is to help you create your own personal paradise that incorporates a beautiful pond, waterfall, fountain - or any combination of these refreshing water features.

With decades of experience designing and field-testing water features and their products, you can rest assured that you're getting the best quality for the best value when you choose Aquascape. Flip through the pages of this catalog and be inspired to create your own personal paradise in your very own yard.

K	Kits	5
F	Filtration.....	15
P	Pumps	32
A	Aerators.....	51
L	Lighting.....	54
PA	Power Accessories.....	63
WT	Water Treatments	65
SC	Seasonal Care	84
FPC	Fish, Plant Care, and Predator Control.....	87
D	Decorative	97
LUG	Liner, Underlayment, and Geotextile	121
PP	Pipe and Plumbing.....	126
IT	Installation Tools.....	130

Aquascape New Products

NEW

Filtration

NEW wetland components designed for easy installation and efficient cleaning.

Snorkel® Vault and Lid



FilterBlox™ Module

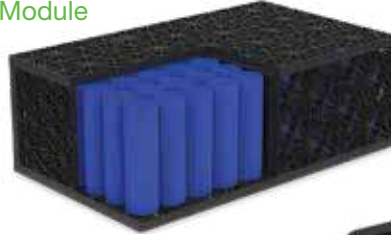

Snorkel® Vault Extension



Centipede® Module End Cap



Centipede® Module

Decorative

NEW covers for mini decorative fountains and ALL Fountain Bowls



Lighting

Large Fountain Light



Plant Care

Larger 864 cu. ft. Bag
Pond Plant Potting Media



Liner Supplies

EPDM Surface Prep and
EPDM Tape Primer Plus



K | F | P | A | L | P | A | W | T | S | C | F | P | C | D | L | U | G | P | P | I | T

Pond, Waterfall, and Fountain Kits



Pond Kit



Pondless® Waterfall Kit



Fountain Kit



Transform your outdoor living space with an Aquascape pond, Pondless Waterfall, or fountain kit. We've bundled the necessary components into convenient kits, making it easier than ever to create naturally balanced, low-maintenance water features.

Aquascape offers DIY friendly and professional grade pond kits, bundling everything you need to build the perfect sized pond for any yard.

Professional-Grade BioFalls® Filter

Provides professional features such as ESA filter mats, rock tray, and water-tight plumbing connection

Professional-Grade Skimmer

Provides professional features such as rigid debris basket, high-quality filter mat, locking weir door, and more

Warm White Pond Lighting

Brings ponds to life at night (included with medium and large kits)

Pond Pump Options

Variety of pump options makes it easy to choose the perfect pump

Dosing System SL

Automatically adds water treatments to your pond

Professional-Grade Medium Pond Kit 11' x 16' Shown



DIY Friendly

Aquascape DIY Backyard Pond Kits

	4' x 6'	6' x 8'	8' x 11'
Item Number	99763	99764	99765
Skimmer	Signature Series 200 Pond Skimmer		
BioFalls	Signature Series 1000 BioFalls		
BioBalls Filter Media	✓		
Pump	EcoWave 2000		
Pipe	Kink-Free 1.5" x 25'		
Liner Material	45 mil EPDM fish safe		
Liner Size	8' x 10' (2.4 x 3 m)	10' x 12' (3 x 3.6 m)	12' x 15' (3.6 x 4.5 m)
Finished Pond Size*	4'L x 6'W x 2' Max Depth	6'L x 8'W x 2' Max Depth	8'L x 11'W x 2' Max Depth
Underlayment	80 sq. ft. (24.3 m)	120 sq. ft. (36.5 m)	180 sq. ft. (24.3 m)
Installation Kit	✓		
Packaged Weight	71.5 lb. (32.4 kg)	85 lb. (38.5 kg)	105 lb. (47.6 kg)
Packaged Dimensions	34"L x 22"W x 23"H		

*May vary based on pond shape and rock size

Professional-Grade

Aquascape Ecosystem Pond Kits					
	Small Pond Kit 8' x 11'	Medium Pond Kit 11' x 16'	Large Pond Kit 21' x 26'	Medium Deluxe Pond Kit 11' x 16'	Large Deluxe Pond Kit 21' x 26'
Item Number	53033	53034 53035	53036 53037 53063	53066	53067
Skimmer	Signature Series 400 Pond Skimmer	Signature Series 1000 Pond Skimmer			
BioFalls	Signature Series 1000 BioFalls	Signature Series 2500 BioFalls	Signature Series 6000 BioFalls	Signature Series 2500 BioFalls	Signature Series 6000 BioFalls
BioFalls Rock Tray	✓				
BioBalls Filter Media	✓				
Pump	AquaSurge 3000	AquaSurge 2000-4000 (Kit #53034) 3-PL 3000 (Kit #53035)	AquaSurge 4000-8000 (Kit #53036) 9-PL 7000 (Kit #53037) SLD 5000-9000 (Kit #53063)	AquaSurge 2000-4000	AquaSurge 4000-8000
Pond Powerhead	—			✓	
Faux Driftwood 30"	—			✓	
Pipe	Flexible PVC 1.5" x 25'	Flexible PVC 2" x 25'	Flexible PVC 2" x 50'	Flexible PVC 2" x 25'	Flexible PVC 2" x 50'
Duel Union Check Valve 2.0	✓				
45 mil EPDM Liner	12' x 15'	15' x 20'	25' x 30'	15' x 20'	25' x 30'
Finished Pond Size*	8'L x 11'W x 2'D	11'L x 16'W x 2'D	21'L x 26'W x 2'D	11'L x 16'W x 2'D	21'L x 26'W x 2'D
Underlayment	180 sq. ft.	300 sq. ft.	750 sq. ft.	300 sq. ft.	750 sq. ft.
Lighting	—		LED Lighting Package		LED Color-Changing Lighting Package
Automated Dosing System with Starter Water Treatment	Dosing System SL			Smart Pond Dosing System XT	
App/WiFi Connected	—		53034		53036 53063
Installation Kit	✓				
Packaged Weight	145 lb. (65.7 kg)	290 lb. (131.5 kg)	488 lb. (221.3 kg)	315 lb. (142.8 kg)	513 lb. (232.6 kg)
Packaged Dimensions	25"L x 40"W x 30"H	48"L x 40"W x 31"H palletized	48"L x 40"W x 41"H palletized	48"L x 40"W x 31"H palletized	48"L x 40"W x 41"H palletized

*May vary based on pond shape and rock size



Each professional kit comes with either the Dosing System SL or the Smart Pond Dosing System XT and a complimentary water treatment.



Deluxe Pond Kits

Includes enhancements to take your pond to the next level:

- Color-changing lighting system
- Smart control for the pump, lights, and Smart Pond Dosing System XT
- Pond Powerhead
- Faux Driftwood 30"



Available in 2 Sizes:

Recreational Pond Kit 9' x 20'



Recreational Pond Kit 19' x 24'



Recreational ponds are more than just a pond, these professionally designed systems transform ordinary landscapes into vibrant, interactive aquatic playgrounds. Whether you're looking to create a serene escape, a place for family fun, or a stunning centerpiece to entertain guests, our kits deliver a one-of-a-kind outdoor experience.

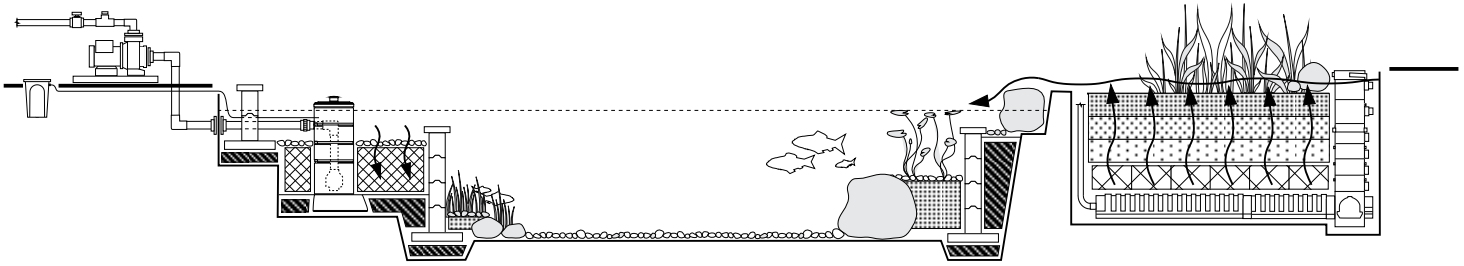

Recreational Pond Kit 9' x 20'

#53073 (US)

#53073C (Canada)

Name/Size	Item Number	Qty
Pondless® Waterfall Vault	49000	1
Pondless® Waterfall Vault Extension	49001	2
Snorkel® Vault and Lid	51007	1
Centipede® Module	51010	3
FilterBlox™ Module	56016	18
AquaBlox® Water Storage Module - Small	29491	18
AquaBlox® Water Storage Module - Large	29492	8
EXT 12000 Pond Pump	45049	1
Flexible PVC Pipe 3" x 50'	29025	1
Flexible PVC Pipe 2" x 25'	29023	1
EXT Pump 2"-3" Plumbing Kit	48027	1
PVC Manifold Kit for 2" or 3"	29156	1
45 mil EPDM Liner Roll - 25' x 50'	29200	1
45 mil EPDM Liner Boxed - 20' x 25'	85004	1
Heavy-Duty Underlayment 15' x 100'	42148	1
Rock Pad Roll	25001	1
Smart Pond Dosing System XT	40040	1
Maintain for Ponds XT - 1 Gal	40049	1
IonGen® System G2	95027	1
Water Feature Installation Kit	22008	1

Recreational Pond Kit 19' x 24'

#53074 (US)

#53074C (Canada)

Name/Size	Item Number	Qty
Pondless® Waterfall Vault	49000	1
Pondless® Waterfall Vault Extension	49001	2
Snorkel® Vault and Lid	51007	1
Centipede® Module	51010	3
FilterBlox™ Module	56016	48
AquaBlox® Water Storage Module - Small	29491	48
AquaBlox® Water Storage Module - Large	29492	16
EXT 18000 Pond Pump	45050	1
Flexible PVC Pipe 3" x 50'	29025	1
Flexible PVC Pipe 2" x 25'	29023	1
EXT Pump 2"-3" Plumbing Kit	48027	1
PVC Manifold Kit for 2" or 3"	29156	1
45 mil EPDM Liner Roll - 40' x 50'	29206	1
45 mil EPDM Liner Roll - 25' x 50'	29200	1
Heavy-Duty Underlayment 15' x 100'	42148	2
Rock Pad Roll	25001	1
Smart Pond Dosing System XT	40040	1
Maintain for Ponds XT - 1 Gal	40049	1
IonGen® System G2	95027	1
Water Feature Installation Kit	22008	1

Pondless® Waterfall Vault

Extremely durable with quick and easy pump access

Kink-Free Pipe

Flexible and resistant to crimping or collapsing

AquaBlox® Water Storage Modules - Small

Store up to 17 gallons per module

Waterfall Spillway

Uses internal barriers to diffuse incoming water

DIY Backyard Waterfall Kit Shown

EcoWave® 2000 Pond Pump

Provides ideal flow with unmatched energy efficiency



DIY Friendly

DIY Backyard Waterfall Kit	
Item Number	83001
Waterfall Spillway	✓
Pondless® Waterfall Vault	✓
AquaBlox®	(2) Small
Pump	EcoWave 2000
Pipe	Kink-Free 1.5" x 25'
Liner Material	45 mil EPDM fish safe
Liner Size	10' x 12' (3 x 3.6 m)
Underlayment	105 sq. ft. (32 m)
Installation Kit	✓
Waterfall and Stream Size*	3' (0.9 m)
Packaged Weight	113 lb. (51.2 kg)
Packaged Dimensions	41"L x 20"W x 25"H

Professional-Grade

	Small Pondless Waterfall Kit (6' Stream)	Medium Pondless Waterfall Kit (16' Stream)	Large Pondless Waterfall Kit (26' Stream)	Medium Deluxe Pondless Waterfall Kit (16' Stream)	Large Deluxe Pondless Waterfall Kit (26' Stream)
Item Number	53038	53039 53040 53064	53041 53042 53065	53068	53069
Waterfall Spillway	✓				
Pondless® Waterfall Vault	✓				
AquaBlox® Water Storage	(3) Small	(5) Small	(5) Large	(5) Small	(5) Large
Pump	AquaSurge 2000-4000	AquaSurge 2000-4000 (Kit #53039) 3-PL 3000 (Kit #53040) SLD 4000-7000 (Kit #53064)	AquaSurge 4000-8000 (Kit #53041) 5-PL 5000 (Kit #53042) SLD 5000-9000 (Kit #53065)	AquaSurge 2000-4000	AquaSurge 4000-8000
Faux Driftwood 35"	—			✓	
Pipe	Flexible PVC 1.5" x 25'	Flexible PVC 2" x 25'	Flexible PVC 2" x 50'	Flexible PVC 2" x 25'	Flexible PVC 2" x 50'
Duel Union Check Valve 2.0	✓				
45 mil EPDM Liner	10' x 10' (Reservoir) 8' x 10' (Stream)	10' x 12' (Reservoir) 10' x 20' (Stream)	10' x 15' (Reservoir) 10' x 30' (Stream)	10' x 12' (Reservoir) 10' x 20' (Stream)	10' x 15' (Reservoir) 10' x 30' (Stream)
Underlayment	100 sq. ft. (30 m)	120 sq. ft. (36.5 m)	180 sq. ft. (54.8 m)	120 sq. ft. (36.5 m)	180 sq. ft. (54.8 m)
Lighting	—	LED Lighting Package		LED Color-Changing Lighting Package	
Automated Dosing System with Starter Water Treatment	Dosing System SL			Smart Pond Dosing System XT	
App/WiFi Connected	—	53039 53064	53041 53065	✓	
Installation Kit	✓				
Packaged Weight	149 lb. (67.5 kg)	298 lb. (135 kg)	379 lb. (172 kg)	323 lb. (146.5 kg)	404 lb. (183.2 kg)
Packaged Dimensions	37"L x 24"W x 28"H	48"L x 40"W x 24"H palletized	48"L x 40"W x 31"H palletized	48"L x 40"W x 24"H palletized	48"L x 40"W x 31"H palletized



Each professional kit comes with either the Dosing System SL or the Smart Pond Dosing System XT and a complimentary water treatment.



Deluxe Pondless Waterfall Kits

Includes enhancements to take your waterfall to the next level:

- Color-changing lighting package
- Smart controls for the pump, lights, and Smart Pond Dosing System XT
- Faux Driftwood

Backyard Waterfall Fountain Kits

Waterfall Spillway

12" spillway diffuses water to provide ideal water flow

Pump Access

Integrated for quick and easy pump access



Flexible PVC Pipe

High-quality, durable, and easy to install

EPDM Liner

Makes it easy to create a small waterfall/stream

AquaBasin® 45

Provides 98 gallons of water storage

Backyard Waterfall Landscape Fountain Kit Shown

Backyard Waterfall Landscape Fountain Kit

Item Number	83013
Waterfall Spillway	12" (30.4 cm)
Reservoir	AquaBasin 45
Pump	AquaSurge 2000 with Low Suction Intake Attachment
Pipe	Flexible PVC 1.5" x 15'
Liner Material	45 mil EPDM fish safe
Liner Size	7.5' x 7.5' (2.3 x 2.3 m)
Underlayment	(2) 7.5' x 1' (2.2 x 0.3 m)
Installation Kit	✓
Waterfall and Stream Size*	3' (0.9 m)
Packaged Dimensions	48"L x 40"W x 35"H palletized

*May vary based on shape and rock size

Fountain
Fiber-resin composite, GFRC, and natural stone options available

Pipe
Silicone or kink-free pipe included

Shown with Fire Fountain Add-On Kit

Pump
Ultra Water Pump provides ideal water flow for each fountain

AquaBasin®
Comes with heavy-duty water reservoir

Stacked Slate Sphere 32" Dia. (81 cm) Fountain Kit Shown

Iron Ore

AquaBasin® 30 Fountain Kits



	Spillway Bowl and Basin 19"/21" Dia. (49/52 cm)	Stacked Slate Sphere 18" Dia. (46 cm)	Stacked Slate Urn 24" H (61 cm)	Faux Basalt Column 24" H (61 cm)
Item Number	78248 78427	78249	78250	78251
Material	GFRC	Fiber-Resin Composite		
Finish	Patina or Iron Ore	-		
Pump	Ultra 800 Water Pump	Ultra 550 Water Pump		
Pipe	3/4" Silicone Tubing with Splitter	3/4" Silicone Tubing		3/4" Corrugated PE Pipe
Packaged Weight	113.5 lb. (51.5 kg)	40.5 lb. (18.3 kg)	45.5 lb. (20.6 kg)	35.5 lb. (16 kg)
Packaged Dimensions	30"L x 30"W x 30"H	30"L x 30"W x 30"H	30"L x 30"W x 27"H	30"L x 30"W x 20"H

AquaBasin® 45 Fountain Kits



	Faux Basalt Column Set of 3 24", 30", 36" H (61, 76, 91 cm)	Stacked Slate Urn 45" H (114 cm)	Scalloped Urn 45" H (114 cm)
Item Number	78366	58090	78270
Material	Fiber-Resin Composite		
Pump	Ultra 2000 Water Pump	Ultra 1100 Water Pump	
Pipe	3/4" Corrugated PE Pipe	3/4" Silicone Tubing	
Packaged Weight	185 lb. (84 kg)	180 lb. (81.6 kg)	145 lb. (65.7 kg)
Packaged Dimensions	40"L x 48"W x 31"H	40"L x 48"W x 54"H	40"L x 48"W x 52"H

NOTE: Faux Basalt Columns not compatible with Fire and Water Torches



	Stacked Slate Sphere 32" Dia. (81 cm)	Stacked Slate Wall 32" H (81 cm)	Spillway Bowl and Basin 32"/40" Dia. (81/102 cm)
Item Number	78290	78269	58087 78426
Material	Fiber-Resin Composite		GFRC
Finish	-		Patina or Iron Ore
Pump	Ultra 1500 Water Pump	Ultra 2000 Water Pump	
Pipe	3/4" Silicone Tubing	(3) 3/4" Silicone Tubing	Corrugated PE Pipe- 3/4" X 15' (4.57 m)
Packaged Weight	195 lb. (88.4 kg)	157 lb. (71 kg)	380 lb. (172 kg)
Packaged Dimensions	40"L x 48"W x 46"H	40"L x 48"W x 54"H	40"L x 48"W x 66"H



Mongolian Basalt Columns Set of 3	
Item Number	58089
Material	Natural Stone
Pump	Ultra 2000 Water Pump
Pipe	Corrugated PE Pipe- 3/4" X 15' (4.57 m)
Packaged Weight	970 lb. (440 kg)
Packaged Dimensions	40"L x 48"W x 31"H

Pond and Waterfall Filtration

NEW

Skimmer Filters



BioFalls®



Wetland Filtration



Check Out Our New Wetland Filtration!

Engineered for flexible design, easier installation, and powerful natural filtration – [see page 26](#) for full details.

Skimmer Filters

Patented Faceplate

Allows you to adjust the water level after installation (Signature Skimmer 1000 only)

Rounded Shape

Provides maximum strength

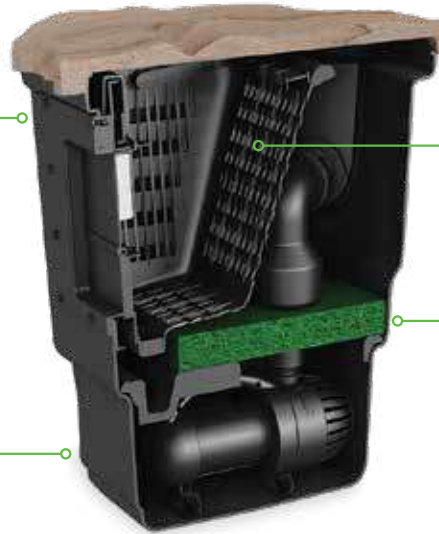

Faux-Rock Lid

Conceals the filter in the surrounding landscape

Rigid Debris Basket

Makes maintenance easier than ever

Rigid Filter Mat

Effectively removes smaller sediment and debris

Signature Series 1000 Pond Skimmer Shown



U.S. Patent 7,144,501	Signature Series 200 Pond Skimmer	Signature Series 400 Pond Skimmer	Signature Series 1000 Pond Skimmer
Item Number	43020	43021	43022
Pond Size	Up to 200 sq. ft.	Up to 400 sq. ft.	Up to 1,000 sq. ft.
Pump Flow Rate	Up to 3,000 GPH / 11,500 LPH	Up to 4,000 GPH / 15,000 LPH	Up to 10,000 GPH / 38,000 LPH*
Recommended Pumps	EcoWave and AquaSurge Pumps	EcoWave, AquaSurge, AquaSurge Adjustable Flow, and PL Pumps	EcoWave, AquaSurge, AquaSurge and SLD Adjustable Flow, and PL Pumps
Weir Size	6"		8"
Adjustable Height Face Plate	—		✓
Locking Weir Door	—	✓	
Debris Net/Basket	Net	Rigid Basket	
Filter Brush Cartridge	Optional	—	
Overflow	Optional	✓	
Filter Mat	—	✓	
Faux-Rock Lid	—	✓	
Dimensions	20"L x 17.5"W x 17.5"H	21.4"L x 18"W x 21"H	21"L x 22"W x 26.5"H
Packaged Weight	14.75 lb. (6.7 kg)	25 lb. (11.3 kg)	34 lb. (15.4 kg)
Packaged Dimensions	22.5"L x 20"W x 18.5"H	25.75"L x 20.5"W x 25"H	25"L x 24"W x 26.75"H

Note: 12PN-10,000 and AquascapePRO 10,000 pumps are too large to fit in these skimmers. Multiple pumps can be used to achieve up to 10,000 gallons per hour.

Reversible Waterfall Lip
Provides the option of using a natural stone spillway

Circular Shape
Provides superior strength and durability



Removable Rock Tray
Holds rocks, plants, and gravel to help hide the filter in the landscape

Filter Media Net
Holds biological filtration media such as BioBalls, sold separately. See page 20

Biological Filter Mats
Two Poly-Flo ESA biological filter mats provide 50% more surface area than traditional mats

Signature Series 6000 BioFalls® Filter Shown



	Signature Series 1000 BioFalls	Signature Series 2500 BioFalls	Signature Series 6000 BioFalls with 2" Bulkhead	Signature Series 6000 BioFalls with 3" Bulkhead
Item Number	99774	09020	29319	29384
Filters Ponds up to	1,000 gal. / 3,800 L	2,500 gal. / 9,500 L	6,000 gal. / 22,700 L	
Pump Flow Rate	Up to 3,000 GPH / 11,400 LPH	Up to 5,000 GPH / 18,900 LPH	Up to 15,000 GPH / 56,800 LPH	
Spillway Width	15"	21.5"	28"	
Bulkhead Port	Single 2"	Dual 2"		Dual 3"
Fittings Included	1.5" PVC slip and 1.5" kink-free insert	Two 2" PVC slip		Two 3" PVC slip
Rock Tray	Sold Separately (#98285)	✓		
Filter Mats	(2) Standard	(2) Poly-Flo ESA		
BioBalls	Sold Separately (#98464)			
Minimum BioBalls Quantity	100	200	400	
Filter Media Nets	1 Included	2 Included	3 Included	
Dimensions	17.5"L x 20.5"W x 17"H	24"L x 29.5"W x 20"H	40"L x 45"W x 29.5"H	
Packaged Weight	11 lb. (5 kg)	28.8 lb. (13 kg)	55 lb. (25 kg)	57 lb. (25.8 kg)
Packaged Dimensions	18.5"L x 20.5"W x 17.5"H	30"L x 24"W x 24"H	40"L x 45"W x 29.5"H	

Fountain Bowl Biological Filter Kits



Make Your Fountain Bowl A Biological Filter

Add a biological filter kit to your choice of Fountain Bowl (not included) to add a decorative filter to any pond or waterfall. Kits are available for both round and square bowls.



Internal Shelves
Included to support filter materials

Rigid Filter Mat
Delivers ideal filtration and effortless cleaning



BioBalls Biological Filter Media and Media Net

Maximize surface area for optimal biological filtration

Plumbing Fittings

Includes plumbing fittings for easy installation



Note: Kits not available for 50" and 60" (127 cm or 152 cm) Fountain Bowls.

	Biological Filter Kits for Round Bowls		Biological Filter Kits for Square Bowls	
Item Number	80016	80017	80018	80019
Fits Bowl Size	32" Dia. (81 cm)	40" Dia. (108 cm)	27" Dia. (69 cm)	33" Dia. (84 cm)
Filters Ponds up to	1,750 gal. / 6,600 L	3,500 gal. / 13,200 L	1,500 gal. / 5,700 L	2,500 gal. / 9,400 L
Pump Flow Rate (minimum recommended)	750 GPH / 2,839 LPH			
Fittings Included	1.5" Rubber Bulkhead and PVC Tee-Fitting			
Support Shelves (4)	✓	✓	✓	✓
Filter Mat	✓	✓	✓	✓
BioBalls Included (Qty)	300	400	300	400
Filter Media Nets	✓	✓	✓	✓
Packaged Dimensions	28"L x 28"W x 10"H	36"L x 36"L x 12"H	24"L x 24"W x 10"H	30"L x 30"W x 10"H

Note: Filtration components also available separately

Control Panel

Use to adjust ionization levels and indicate when probe is exhausted

Flow Chamber

Positions probe at an angle to prevent clogging and optimize results



 Only Available for Sale in the USA

IonGen® System G2

Packaged Weight: 5 lb. (2.3 kg)

Packaged Dimensions: 18"L x 4.5"W x 14"H

#95027 (US)

Test Kits Included for KH and Copper Levels

Our best defense against string algae!



IonGen® System G2 Accessories

	IonGen® Probe for G2 System	Copper Test Kit	KH/Alkalinity Test Kit
Item Number	95028	96020	96019
Purpose	For 2nd generation flow chamber	Measures residual copper	Measures KH/alkalinity
Packaged Weight	.5 lb. (.23 kg)	.2 lb. (0.09 kg)	.2 lb. (0.09 kg)
Packaged Dimensions	3"L x 2"W x 6"H	4"L x 1.5"W x 5"H	4"L x 1.5"W x 5"H

Add-On Pond Filters and Filter Media



Add-On Filters

	Pond Waterfall Filter	Submersible Pond Filter	Container Water Garden Filter
Item Number	77020	95110	77005
Pond Volume	1,000 gal. / 3,785 L	Up to 800 gal. / 3,028 L	Up to 50 gal. / 189 L
Maximum Flow Rate	5,000 GPH / 18,500 LPH	—	—
Recommended Pump	—	Ultra 1100 Water Pump (#91008)	—
Fittings Included	1", 1.25", 1.5"	3/4", 1", 1.25"	Multiple Fittings Included
Filter Dimensions	20"L x 15"W x 12.5"H	13"L x 11"W x 5"H	2"L x 1.5"W x 7"H
Packaged Weight	8.6 lb. (3.9 kg)	11 lb. (5 kg)	1 lb. (.45 kg)
Packaged Dimensions	21.5"L x 16.5"W x 14.5"H	12"L x 6"W x 12.75"H	4.25"L x 3.25"W x 8"H

Center Channel
Allows the balls to be strung together making cleaning easier

Ideal Filter Media
Easy to clean, long lasting, and lightweight

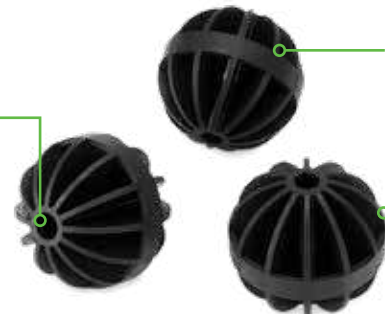

Compact Size
Allows for placement into smaller areas

Paddle Wheel Design
Helps to degas and aerate water

BioBalls Biological Filter Media Shown



	BioBalls Biological Filter Media (100 Count)	BioBalls Biological Filter Media (1,000 Count)	BioBalls Filter Media Net
Item Number	98464	56014	29069
Count	100 BioBalls	1,000 BioBalls	1 Net
Size	1.5" Dia.		24" x 28"
Media Net	Included	Sold Separately	—
Packaged Weight	2.25 lb. (1 kg)	24 lb. (10.8 kg)	.25 lb. (113 g)
Packaged Dimensions	8"L x 8"W x 6.5"H	18"L x 12"W x 14"H	7.25"L x 10.5"W x 1"H

10' Long and 56" Wide
Easily cut to desired size/shape



Popular Media

Used in skimmer and biological filters

Coarse Filter Media Roll Shown

Rigid Filter Media Mats

Provides efficient mechanical and biological filtration for your pond

Three Options

Available in 3 different densities



Easy to Clean

Makes maintenance quick and easy

Measures 24" by 39"

Easily cut to desired shape/size



Filter Rolls and Mats

	Dense Filter Media Roll 1" Thick	Coarse Filter Media Roll 1.25" 2" Thick	Low Density Rigid Filter Mat 1.5" Thick	Medium Density Rigid Filter Mat 1.5" Thick	High Density Rigid Filter Mat 1.5" Thick
Item Number	99325	99321 99323	80003	80004	80005
Packaged Weight	8.75 lb. (4 kg)	8.25 lb. 10 lb. (3.7 kg) (4.5 kg)	4.25 lb. (2 kg)	3.5 lb. (1.6 kg)	3.25 lb. (1.5 kg)
Packaged Dimensions	10'L x 56"W		24" x 39"W		

UltraKlear® UV Clarifiers

Electronic Ballast
Ensures optimum wattage and bulb output

Internal Swirl Sleeve
Slows water flow to maximize effect of UV



UltraKlear™ 1000
UV Clarifier Shown

Discharge Options
Choose which size is best for your installation



Fittings Included
Wide variety of included fittings and mounting brackets simplify installation



	UltraKlear 1000	UltraKlear 2500	UltraKlear 5000
Item Number	95036	95037	95038
Average Pond Size Recommendation	1,000 gal. / 3,500 L	2,500 gal. / 9,000 L	5,000 gal. / 18,500 L
Max Flow Rate	500 GPH / 1,500 LPH	1,000 GPH / 3,500 LPH	1,500 GPH / 5,500 LPH
UV Wattage	14	28	55
Power Cord Length	20'		
Discharge Hose Diameter	1", 1.25", 1.5"		
Dimensions	23.5"L x 5.5"W x 3.75"H	33.5"L x 5.5"W x 3.75"H	43"L x 5.5"W x 3.75"H
Packaged Weight	6.5 lb. (2.9 kg)	8.75 lb. (3.9 kg)	10 lb. (4.5 kg)
Packaged Dimensions	24"L x 11"W x 4"H	34"L x 9.5"W x 4"H	44.5"L x 9.5"W x 4"H



UltraKlean Pond Filter

Includes ultraviolet clarifier, self-cleaning function, and integrated electronic bulb-saver function

AquaForce® Solids-Handling Pond Pump

Provides ideal flow for the filter and can be placed directly into the pond

UltraKlean™ 2500 Pond Filtration Kit Shown

Kink-Free Pipe

Flexible and resistant to crimping or collapsing

Hose Clamps

Stainless steel hose clamps secure plumbing connections

UltraKlean Pond Filter Kits			
	UltraKlean 1500 Kit	UltraKlean 2500 Kit	UltraKlean 5500 Kit
Item Number	95058	95059	95060
Average Pond Size	1,500 gal. / 5,500 L	2,500 gal. / 9,000 L	3,500 gal. / 13,000 L
Filter Model	UltraKlean 2000		UltraKlean 3500
UV Clarifier	14		28
Included Pump	AquaForce 1000	AquaForce 2700	AquaForce 3500
Pipe	Kink-Free 1.5" x 25'		
Stainless Steel Clamps	4	4	7
2-Way Flow Control Valve	—		✓
Packaged Weight	39.75 lb. (18 kg)	40 lb. (18.1 kg)	48.5 lb. (22 kg)
Packaged Dimensions	23.5"L x 21.5"W x 21"H	23.5"L x 21.5"W x 21"H	23.5"L x 21.5"W x 21"H



UltraKlean Pond Filters		
	UltraKlean 2000	UltraKlean 3500
Item Number	95053	95054
Average Pond Size	2,000 gal. / 7,500 L	3,500 gal. / 13,000 L
Max Flow Rate	2,700 GPH / 10,000 LPH	5,200 GPH / 19,500 LPH
UV Wattage	14	28
Power Cord Length	20'	
Discharge Hose Diameter	1", 1.25", 1.5"	
Dimensions	13"L x 13"W x 17"H	13"L x 13"W x 21.5"H
Packaged Weight	17 lb. (7.7 kg)	22 lb. (10 kg)
Packaged Dimensions	14"L x 14"W x 18"H	14"L x 14"W x 22.5"H

K | F | P | A | L | P | A | W | T | S | C | F | P | C | D | L | U | G | P | P | I | T

Pondless® Waterfall Vault & Waterfall Spillway

Inspection Port

Quickly check water levels without removing the lid

Large Interior

Fits a wide range of pump sizes

Water Intakes

Optimize water circulation



Vault Extension

Increases vault height for deeper applications

	Pondless® Waterfall Vault	Pondless® Waterfall Vault Extension
Item Number	49000	49001
Maximum Flow Rate	Up to 12,500 GPH / 47,000 LPH	—
Access Opening Dimensions	16"L x 16"W	
Dimensions	23"L x 17"W x 25.5"H	16"L x 16"W x 9"H
Packaged Weight	14 lb. (6.4 kg)	5 lb. (2.3 kg)
Packaged Dimensions	23"L x 18"W x 22.5"H	16"L x 16"W x 10"H

Wide Opening

Handles high flow rates



Watertight Connection

Professional, leak-free plumbing hook-up

Internal Barriers

Diffuse the water into a smooth-flowing waterfall

	Waterfall Spillway 12"	Waterfall Spillway 22"
Item Number	77023	77000
Bulkhead Port	Single 2"	
Fittings Included	2"PVC Slip, and 1.5" Barbed Hose Fitting	
Maximum Flow Rate	4,000 GPH / 15,000 LPH	7,500 GPH / 28,000 LPH
Dimensions	10.5"L x 14"W x 5"H	17.5"L x 24"W x 5"H
Packaged Weight	4.5 lb. (2 kg)	9 lb. (4 kg)
Packaged Dimensions	14"L x 15"W x 5.5"H	24"L x 17"W x 5"H

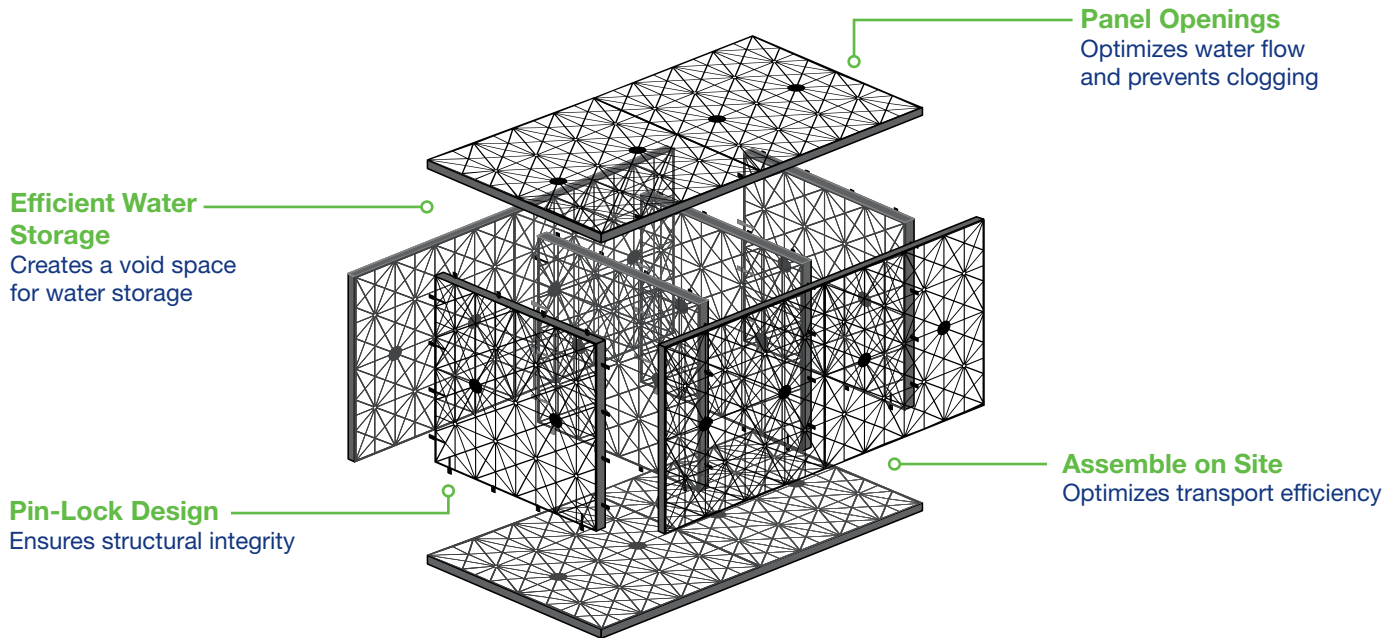

	Small	Large
Item Number	29491*	29492*
Volume	17 gal. / 64.35 L	32 gal. / 121.13 L
Load Bearing Weights	5,472 lb./sq. ft.	
Dimensions	26.5"L x 16"W x 9.5"H	26.5"L x 16"W x 17.5"H
Packaged Weight	11 lb. (4 kg)	16 lb. (7.3 kg)
Packaged Dimensions	27"L x 16"W x 4"H	27"L x 16"W x 6"H

*AquaBlox® are available in bulk quantities, call for information

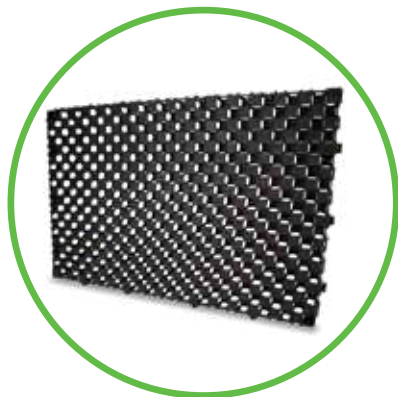

Flo-Cell 30mm Drainage Cell

Use these versatile Flo-Cell panels for the following:

- Weight displacement for AquaBasin® or AquaBlox® Water Storage Modules
- Shimming rocks to a desired level
- Removable/cleanable interlocking panels for AquaBlox® Water Storage Modules
- Various drainage solutions

Packaged Weight: 1.5 lb (.68 kg)

Packaged Dimensions: 24"L x 16"W x 1.25"H

#94012

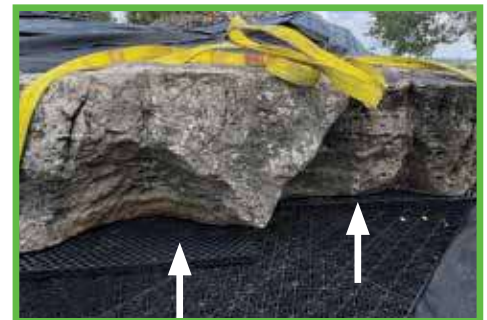



What Is a Wetland Filter?

A modular, upflow-constructed filtration system designed to mimic the natural filtration processes of a wetland. Engineered for outstanding water quality, this system is scalable for a wide variety of pond sizes and enhances the visual appeal of your water feature.

Now, new and improved!

- New components simplify installation, minimizing setup time and complexity
- Maximized surface area for optimal biological filtration
- New design makes filter cleaning easier than ever



Snorkel® Vault and Lid



Snorkel® Vault Extension



Centipede® Module



Centipede® Module End Cap

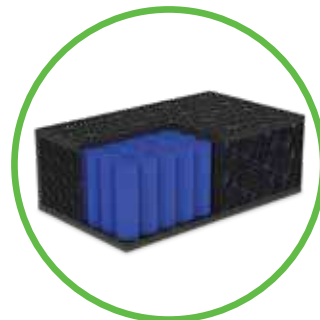

FilterBlox™ Module (Patent Pending)

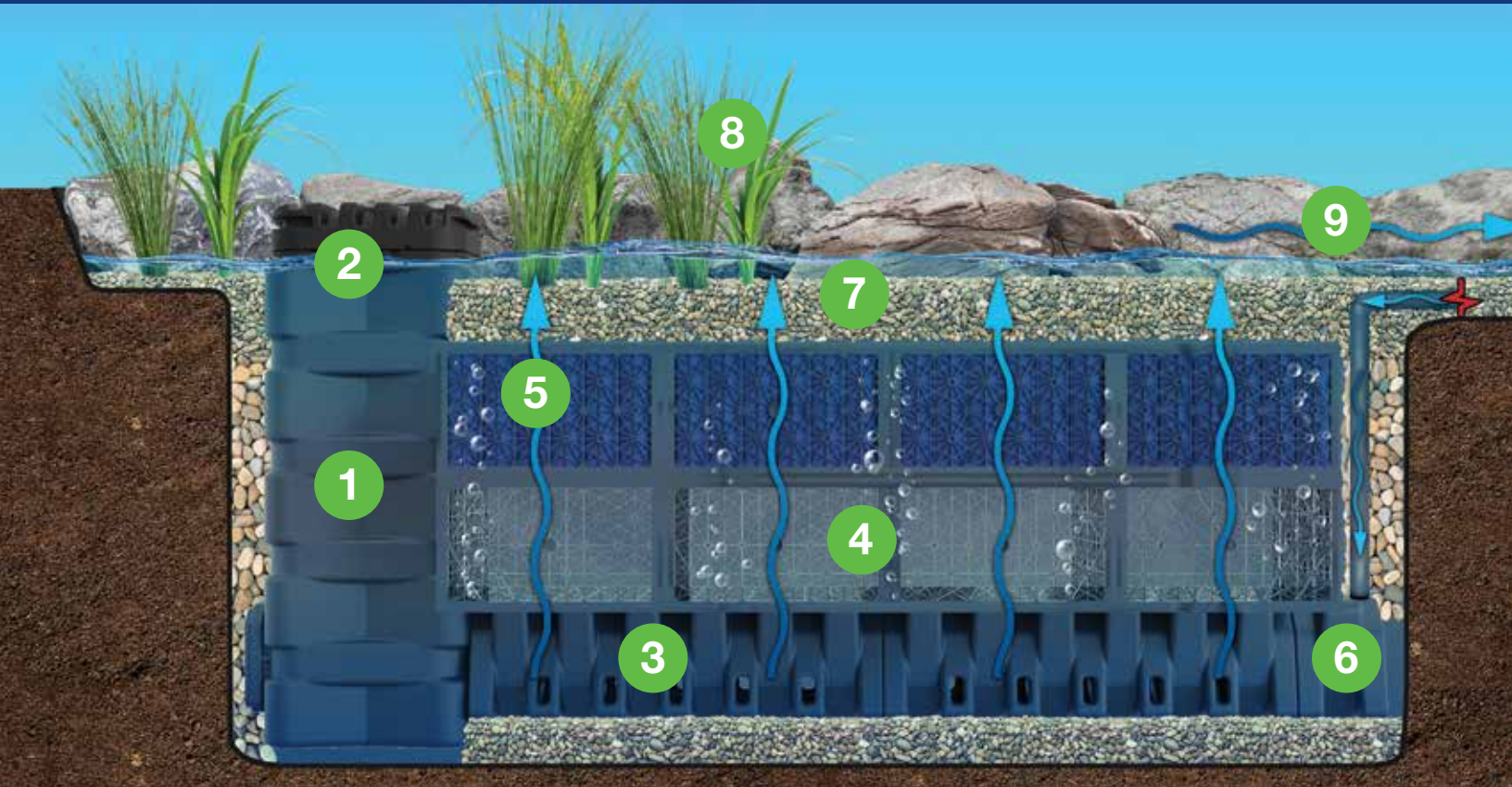

1. Snorkel® Vault

Provides a central access point for cleaning and maintaining the wetland filter

2. Snorkel Vault Lid

Protects the Snorkel Vault from debris entry, withstanding foot traffic for safe use

3. Centipede® Module

Distributes water evenly throughout the wetland filter bed for maximum contact with filter media

4. AquaBlox® Water Storage Modules

Act as a settlement chamber, allowing solids to drop out of suspension before the water rises through the filter media

5. FilterBlox™ Module (patent pending)

Use internal Biological Filter Tubes to maximize surface area, greatly increasing capacity for filtration

6. Centipede End Cap

Convenient connection point for incoming plumbing

7. Rocks and Gravel

Provides a natural substrate for additional filtration and further removal of fine sediments

8. Optional Plants

Provide phyto-filtration, further stripping nutrients from the water as it passes while providing aesthetic appeal

9. Clean Filtered Water

Returns to pond for recirculation

Snorkel® Vault and Centipede®



	Snorkel Vault and Lid	Snorkel Vault Extension	Centipede Module	Centipede Module End Cap
Item Number	51007	51008	51010	51011
Includes	Snorkel Vault, Lid & Centipede End Cap	-	-	-
Dimensions	19.25"L x 16"W x 42.5"H	16"L x 16" W x 9.5"H	33.5"L x 16"W x 9.5"H	7"L x 16"W x 9.5"H
Weight	27.9 lb. (12.7 kg)	5.2 lb. (2.4 kg)	13.5 lb. (6.1 kg)	3 lb. (1.4 kg)

Component Connections

Slide together secure engagement

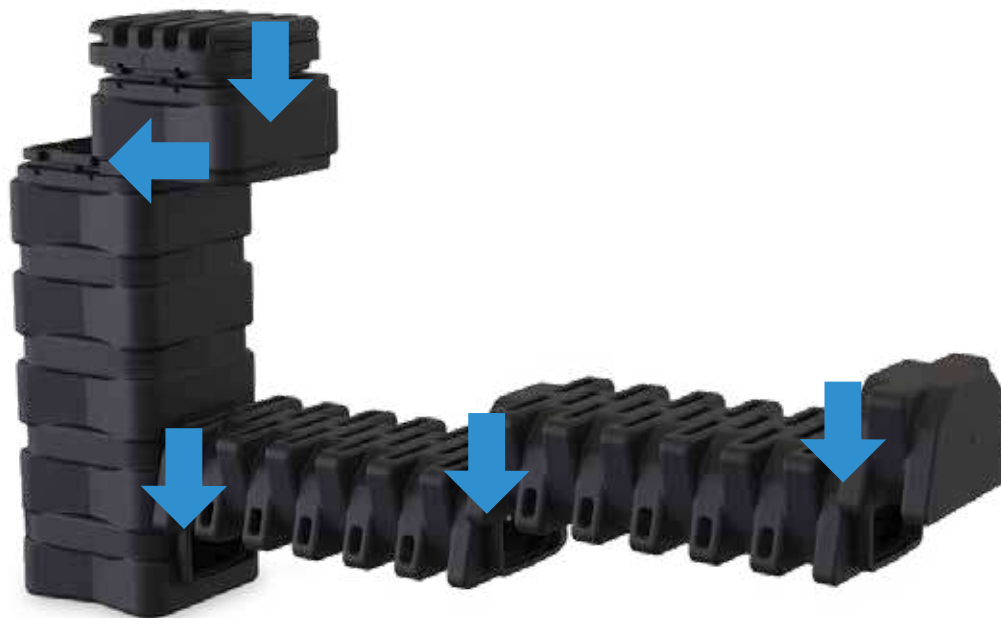

Go Beyond the Limits

The new Snorkel Vault lets you expand in both directions.

Simply cut the rear connection point and add another row of Centipede Modules for ultimate design expandability.



Internal Biological Filter Tubes

Maximize surface area for unmatched biological filtration

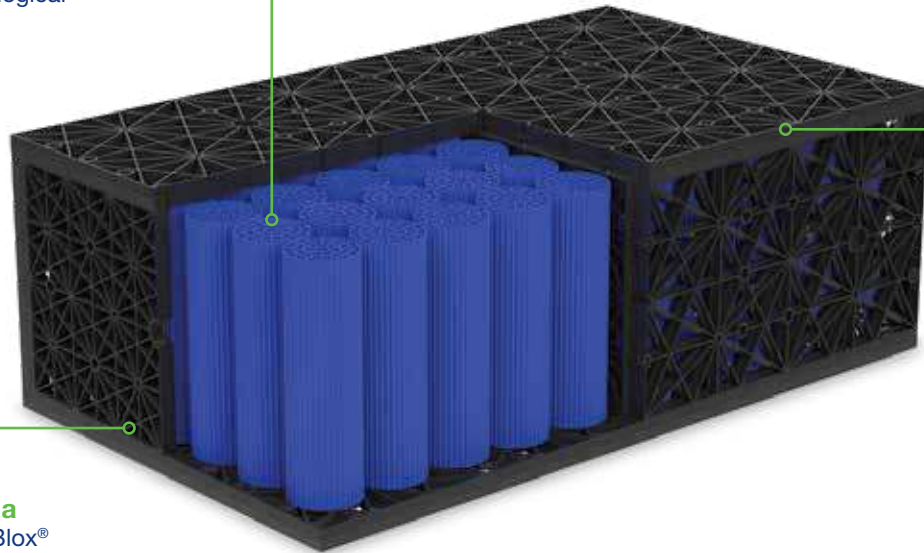

Stackable, Modular Units

For custom filter capacity

Integrated Media

Inside small AquaBlox® Water Storage Modules for optimized structure and modular interaction with other components

Biological Filter Tube



1. Water Flow Channel

Optimizes cleaning and flow during filtration

2. Expanded Surface Area

Over 5x more than gravel and 2x more than BioBalls®

FilterBlox Module	
Item Number	56016
Includes	60 Biological Filter Tubes
Dimensions	26.5"L x 16"W x 9.5"H
Weight	19.25 lb. (8.75 kg)

Big Filtration, Small Footprint

- Historically designed for large ponds, wetlands can now be scaled down for smaller projects
- New shorter Centipede® and Snorkel® allow you to build compact wetland filters (see photo)
- Perfect for small ponds or limited installation spaces

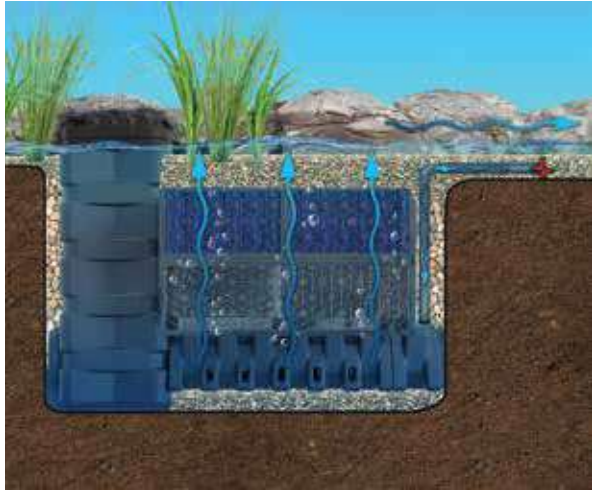

Want More Filtration?

Pair Snorkel Vault Extensions with additional FilterBlox™ Layers for:

- Heavy fish loads
- High human interaction
- Limited space applications



Pond, Waterfall, and Fountain Pumps



Pond & Waterfall Pumps



Fountain Pumps



Pumps are the heart of any water feature, circulating water and providing oxygenation to help maintain a stable ecosystem.

How to Choose a Pond Pump

Did you know our website can walk you through the process of finding the right pump for your water feature?

STEP 1 Calculate Your Pump Requirements Find your recommended flow rate and water feature type

The screenshot shows a web form with two tabs: 'Pond' (selected) and 'Pondless'. Under 'Pond Dimensions', there are input fields for Length in Feet, Width in Feet, and Avg Depth in Feet. Under 'Waterfall Width', there are input fields for Width in Inches and a dropdown for Head Height (set to 2'). At the bottom, there are input fields for Discharge in Feet, Pipe Length in Feet, and Pipe Diameter, followed by a 'Calculate' button.

Confirm Your Water Feature Type

Pond or Pondless® Waterfall?

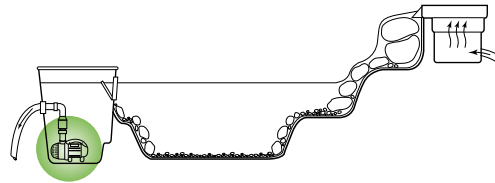

Pond

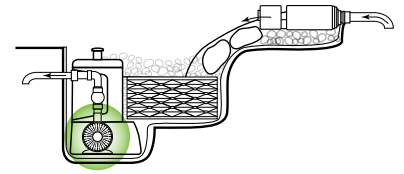

Pondless

STEP 2 Choose Your Pump Location For use in a pond skimmer, Pondless Waterfall Vault, or directly in the pond.

Pond Pumps

For Use in Pond Skimmers or Pondless Waterfall Vault

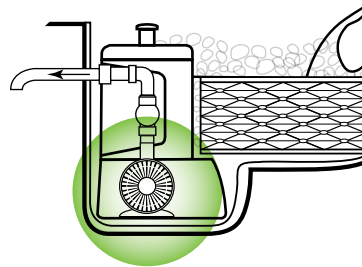
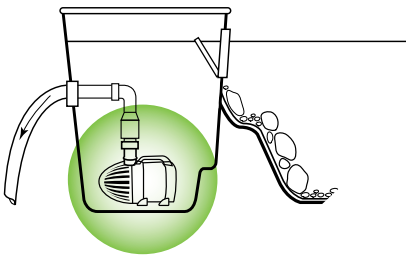

In-Pond Pumps

For Use Directly in the Pond

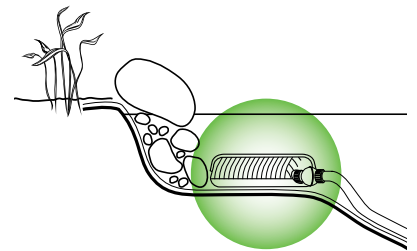

STEP 3 Choose Your Pump Model Select a pump model that best suits your needs!



Low Maintenance,
Solids-Handling Pumps

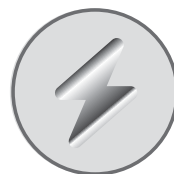

Energy-Efficient Pumps

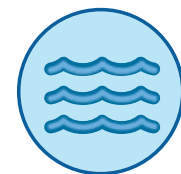

In-Pond Pumps

AquaSurge® Pond Pump

Locking Knob
Allows for quick and maintenance

Smart Pump Receiver
Provides on-board flow adjustment and connects to the Aquascape Smart Control App
(For use with the adjustable flow pump models only)

Ceramic Shaft
Unique ceramic shaft and cooling port prevent pump from overheating



Fittings
Includes a comprehensive set of high-quality fittings



AquaSurge® 2000-4000 Pond Pump Shown

Asynchronous Motor
Makes this pump more powerful and more efficient than traditional pond pumps



Universal Remote for Adjustable Flow Pumps

- For use with adjustable flow pumps only

Packaged Weight: .3 lb. (.14 kg)
Packaged Dimensions: 5"L x 2.75"W x 1.25"H
#45041

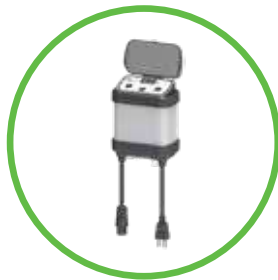

Smart Pump Receiver

- Upgrade your older model adjustable flow pump with a new Smart Pump Receiver

Packaged Weight: 1.5 lb (.68 kg)
Packaged Dimensions: 8.5"L x 5.5"W x 4.5"H
#45064



Low Suction Intake Attachment

- Not compatible with AquaSurge 4000-8000

Packaged Weight: .5 lb. (.23 kg)
Packaged Dimensions: 5.75"L x 4.5"W x 5.75"H
#91117



Adjustable Flow Pump Extension Cord

- Extend pumps 25' from the receiver
- For use with adjustable flow pumps only

Packaged Weight: 2 lb. (0.9 kg)
Packaged Dimensions: 14"L x 4.25"W x 4.25"H
#45048



AquaSurge and AquaSurge Adjustable Flow Pond Pump Models

	2000	3000	4000	5000	2000-4000 Adjustable Flow	4000-8000 Adjustable Flow
Item Number	91017	91018	91019	91020	45009	45010
Maximum Flow Rate	2,193 GPH	3,196 GPH	3,947 GPH	5,284 GPH	3,947 GPH	7,793 GPH
	8,000 LPH	12,000 LPH	14,500 LPH	20,000 LPH	14,500 LPH	29,500 LPH
Adjustable Flow	—				✓	
Maximum Head Height	12.5' (3.8 m)	15' (4.6 m)	18.5' (5.6 m)	24' (7.3 m)	18.5' (5.6 m)	28' (8.5 m)
Motor Type	Asynchronous					
Wattage	160	165	215	360	180 to 215	500 to 600
Amperage	1.3	1.4	1.82	3	1.82	5.5
Pump Discharge Diameter	1.5" MPT					
App/WiFi Connected	—				✓	
Pump Dimensions	11.7"L x 5.5"W x 7"H			13.4"L x 5.8"W x 7.3"H		
Packaged Weight	10 lb. (4.5 kg)	10.25 lb. (4.6 kg)	12.75 lb. (5.8 kg)	14 lb. (6.4 kg)	13 lb. (5.9 kg)	16 lb. (7.3 kg)
Packaged Dimensions	13.25"L x 9"W x 9"H	13.25"L x 9"W x 9.75"H	15"L x 9.25"W x 10.5"H	15"L x 9.25"W x 11.25"H	15"L x 9.5"W x 10.5"H	15"L x 9.5"W x 12"H

AquaSurge and AquaSurge Adjustable Flow Pond Pump Flow Chart (GPH)

Model	Max Head Height	Application Head Height							
		0'	5'	10'	15'	20'	25'	30'	35'
2000	12.5'	2193	1850	1465	0	GPH			
3000	15'	3196	2700	2350	0	GPH			
4000	18.5'	3947	3750	3350	2250	0	GPH		
5000	24'	5284	5000	4750	3250	1750	0	GPH	
2000-4000	18.5'	3947	3750	3350	2250	0	GPH		
4000-8000	28'	7793	7350	7000	5850	4300	2000	0	GPH

BEST Operating Zone MAXIMUM Operating Zone

Solids-Handling Capability

Allows the pump to pass solids, significantly reducing clogging and maintenance



Smart Pump Receiver

Connects to the Aquascape Smart Control App, allowing you to control the pump with your smartphone or tablet

2" Outlet

Allows for quick, easy installation

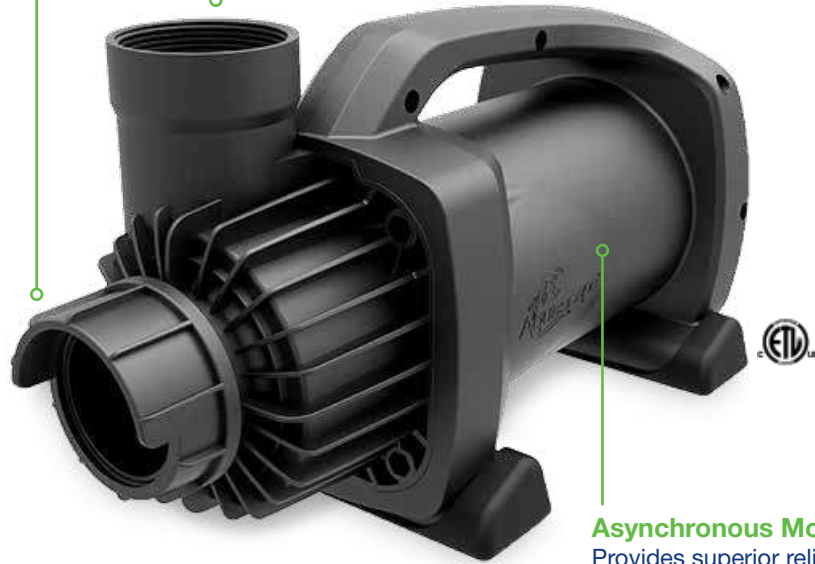

Asynchronous Motor

Provides superior reliability and longevity

SLD 4000-7000 Adjustable Flow Pond Pump Shown



Universal Remote for Adjustable Flow Pumps

- For use with adjustable flow pumps only

Packaged Weight:
.3 lb. (.14 kg)

Packaged Dimensions:
5"L x 2.75"W x 1.25"H

#45041



Smart Pump Receiver

Upgrade your older model adjustable flow pump with a new Smart Pump Receiver.

- 45064 - Compatible with the SLD 2000-5000 and SLD 4000-7000

#45064

Smart Pump Receiver Large

- Compatible with the SLD 5000-9000 ONLY

45065

Packaged Weight:
1.5 lb (.68 kg)

Packaged Dimensions:
8.5"L x 5.5"W x 4.5"H



Adjustable Flow Pump Extension Cord

- Extend pumps 25' from the receiver
- For use with adjustable flow pumps only

Packaged Weight:
2 lb. (0.9 kg)

Packaged Dimensions:
14"L x 4.25"W x 4.25"H

#45048



SLD and SLD Adjustable Flow Pond Pump Models

	5000	7000	9000	2000-5000	4000-7000	5000-9000
Item Number	45066	45067	45068	45046	45036	45037
Maximum Flow Rate	5,952 GPH	7,910 GPH	10,291 GPH	5,952 GPH	7,910 GPH	10,291 GPH
	22,531 LPH	29,943 LPH	38,956 LPH	22,531 LPH	29,943 LPH	38,956 LPH
Adjustable Flow	-			✓		
Maximum Head Height	16.7' (5 m)	25' (7.6 m)	33' (10 m)	16.7' (5 m)	25' (7.6 m)	33' (10 m)
Motor Type	Asynchronous					
Wattage	375	605	1006	235-373	487-605	655-1006
Amperage	3.1	5.2	8.4	3.1	5.2	8.4
Pump Discharge Diameter	2" FPT					
App/WiFi Connected	-			✓		
Pump Dimensions	13"L x 6.25"W x 7"H					
Packaged Weight	13.5 lb. (6 kg)	16.5 lb. (2.7 kg)	17.5 lb. (8 kg)	14.5 lb. (1.8 kg)	17.6 lb. (8 kg)	18.75 lb. (8.5 kg)
Packaged Dimensions	15"L x 11.5"W x 9.5"H	15"L x 11.75"W x 9.5"H	15"L x 11.75"W x 10.75"H	15"L x 11.5"W x 9.5"H	15.25"L x 12"W x 9.5"H	15.25"L x 12"W x 10.75"H

SLD and SLD Adjustable Flow Pond Pump Flow Chart (GPH)

Model	Max Head Height	Application Head Height								
		0'	5'	10'	15'	20'	25'	30'	35'	
5000	16.7'	5952	4545	2995	1048	0	GPH			
7000	25'	7910	7010	5886	4703	3042	0	GPH		
9000	33'	10291	9709	8251	6828	5407	3741	2302	0	GPH
2000-5000	16.7'	5952	4545	2995	1048	0	GPH			
4000-7000	25'	7910	7010	5886	4703	3042	0	GPH		
5000-9000	33'	10291	9709	8251	6828	5407	3741	2302	0	GPH

BEST Operating Zone
 MAXIMUM Operating Zone

P PL and PN Solids-Handling Pond Pump

Overload Protection

Built in thermal overload protection prevents pump from overheating

Unmatched Dependability

Double silicone carbide mechanical seals and oil lifter provide unmatched dependability

Shielded Intake

Prevents air from entering pump when used in shallow water applications



5-PL 5000 Solids-Handling Pond Pump Shown

High Efficiency

Continuous duty motor operates at lower temperature which extends pump life

High Volume Flow

Channel impeller and specially designed volute allows for efficient, high volume water flow

Reinforced Power Cord

Anti-wicking, watertight design improves durability and prevents issues with electrical shorting



12-PN 10000 Solids-Handling Pond Pump Shown

K | F | P | A | L | P A | W T | S C | F P C | D | L U G | P P | I T



Aquascape PL and PN Solids-Handling Pond Pump Models

	3-PL	5-PL	9-PL	8-PN	12-PN
Item Number	29975	29976	29977	29495	30391
Maximum Flow Rate	3,000 GPH	5,300 GPH	7,300 GPH	5,548 GPH	10,000 GPH
	11,400 LPH	20,000 LPH	27,500 LPH	21,000 LPH	37,500 LPH
Maximum Head Height	14' (4.3 m)	23' (7 m)	35' (10.6 m)	56' (17 m)	23' (7 m)
Motor Type	Direct Drive				
Wattage	330	620	1000		900
Amperage	3.2	5.6	8.6	9.1	
Pump Discharge Diameter	2"				3"
Pump Dimensions	11.7"L x 5.6"W x 7.1"H	13.2"L x 5.9"W x 7.3"H	14"L x 5.9"W x 7.3"H	9.3"L x 6.4"W x 15"H	11.7"L x 7.7"W x 15.1"H
Packaged Weight	16 lb. (7.3 kg)	19 lb. (8.6 kg)	23 lb. (10.4 kg)	24 lb. (10.8 kg)	36 lb. (16.3 kg)
Packaged Dimensions	13"L x 9.75"W x 9.5"H	15"L x 9.75"W x 9.5"H	15"L x 9.75"W x 9.5"H	17.25"L x 10.25"W x 9"H	12.5"L x 9"W x 17.75"H

Aquascape PL & PN Series Pump Flow Chart (GPH)

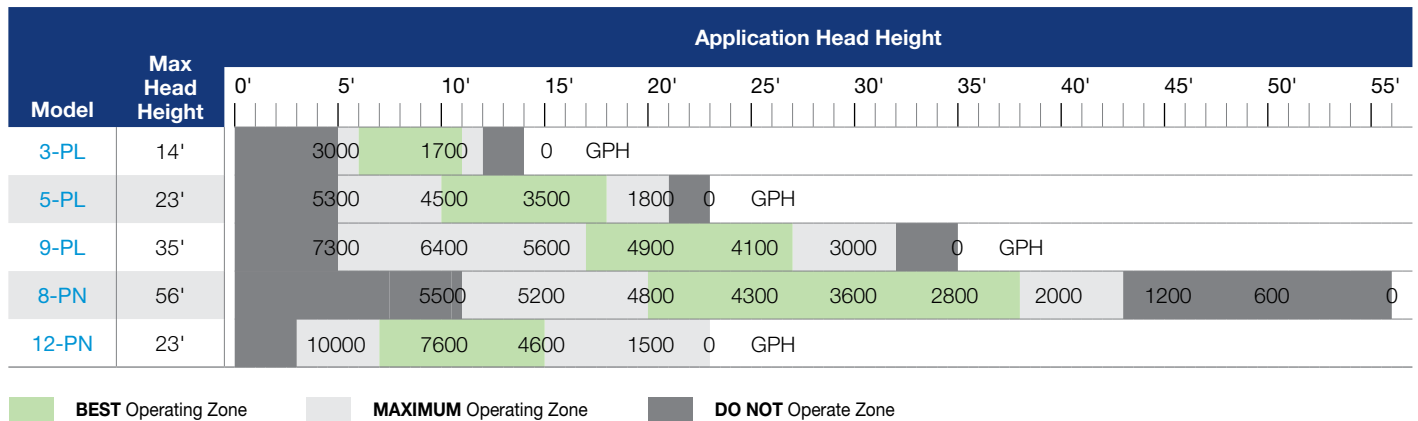

External/In-Line Pump

Ideal for water features requiring high flow in a non-submersible application



TEFC

Totally enclosed fan-cooled motor



Customized Electrical

Junction box located on pump motor allows 115V or 230V electric to be customized on site

EXT 18000 Pond Pump Shown

EXT Pump 2"-3" Plumbing Kit

- Includes fittings, flanges, valves, and hardware to install the EXT pump at the perimeter of the pond's edge.

Packaged Weight: 21 lb.

Packaged Dimensions: 12.5"L x 12.5"W x 12"H

#48027

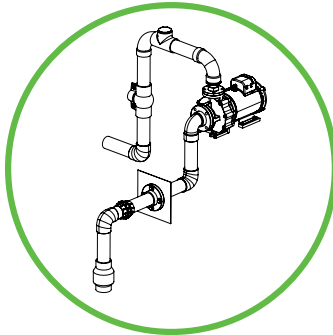

EXT Pump 3" Plumbing Kit

- Includes fittings, flanges, valves, and hardware to install the EXT pump at the perimeter of the pond's edge.

Packaged Weight: 25 lb.

Packaged Dimensions: 12.5"L x 12.5"W x 12"H

#48044

EXT pumps are installed near the water feature with the intake pulling from a pre-filtered source, such as a Pondless® Waterfall Vault and the discharged water sent to wetland filters, waterfalls, or jets.

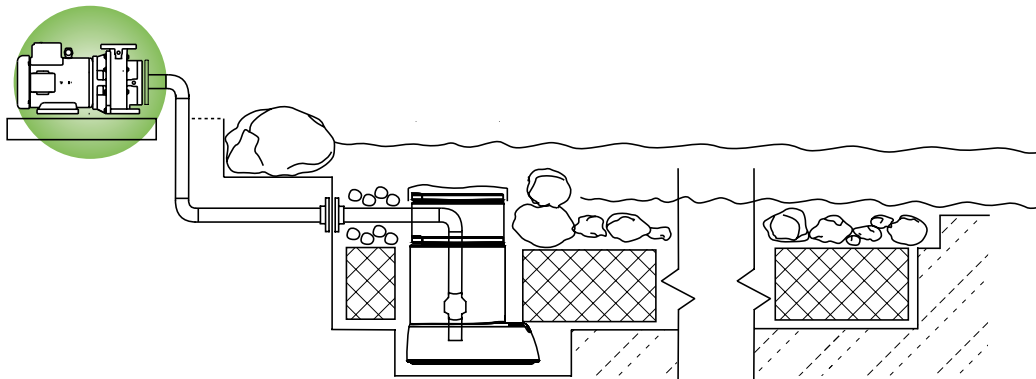

Aquascape EXT Pond Pumps are ideal for providing recirculating water in recreational ponds that require an external style of pump. The high flow rates of the EXT pumps make them perfect for supplying water to waterfalls, wetland filters, and water jets.



EXT Pond Pump Models				
	12000	12000-3P	18000	18000-3P
Item Number	45049	45051	45050	45052
Maximum Flow Rate	12,500 GPH / 47,318 LPH		18,400 GPH / 69,652 LPH	
Maximum Head Height	21'		45'	
Motor Type/HP	143JM / 3/4 hp	143JM / 1 HP	184JM / 3 HP	
Wattage	1,100	736	3,300	1,932
Maximum Current Amps @	115V - 10 A / 230V - 5 A	230V - 3.2 A / 460V - 1.6 A	115V - 30 A / 230V - 15 A	230V - 8.4 A / 460V - 4.2 A
Pump Discharge Diameter	2"			
Pump Inlet Diameter	3"			
Phase	Single	3-Phase	Single	3-Phase
Pump Dimensions	19.3"L x 11.9"W x 11.75"H		21.15"L x 12.9"W x 11.75"H	21.9"L x 12.65" W x 11.75"H
Packaged Weight	114 lb. (51.7 kg)	115 lb. (52 kg)	114 lb. (51.7 kg)	115 lb. (52 kg)
Packaged Dimensions	30"L x 17.5"W x 18"H			

EXT Pond Pump Flow Chart (GPH)

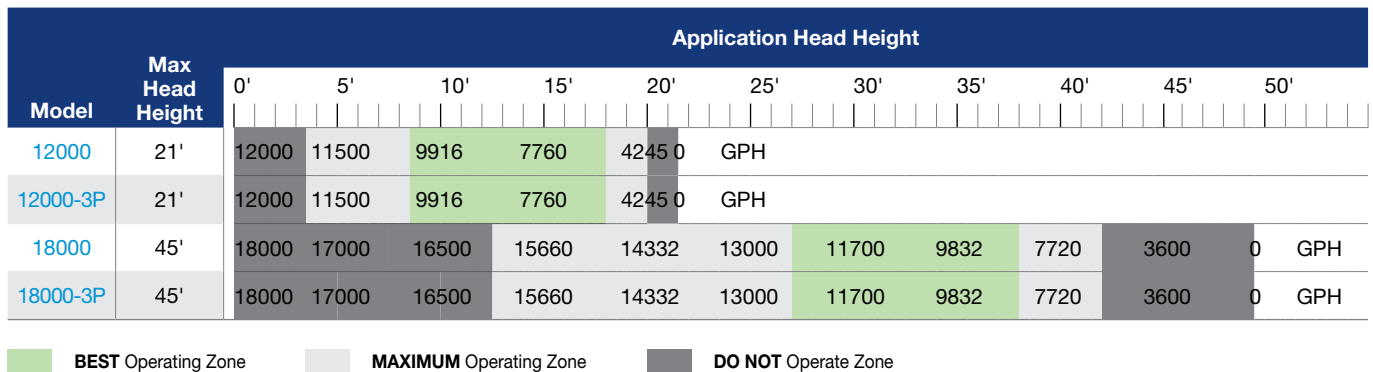

See page 129 for Plumbing Kits

3-Year Warranty

Confidence in the advantages of today's technology and reliable construction

**Overload Sensor**

Built-in overload sensor prevents pump damage

**Intelligent Mag-Drive Motor**

Provides significant electrical cost savings

EcoWave 4000 Pond Pump Shown

**Low Suction Intake Attachment**

- Allows pumps to be operated in shallow applications such as the AquaBasin® 45.
- Compatible with the EcoWave 2000 & 3000.

Packaged Weight: .5 lb. (.23 kg)

Packaged Dimensions:
5.75"L x 4.5"W x 5.75"H

#91117

Note: Not compatible with EcoWave pump models 4000 and 5000

**Check Valve Adapter for EcoWave Pond Pump - 2"**

- Designed to make it quick and easy to connect EcoWave pumps to the Dual Union Check Valve 2.0 (**#48026**).

Packaged Weight: .5 lb. (.23 kg)

Packaged Dimensions:
3.75"L x 3.75"W x 4"H

#88058

Note: Compatible with EcoWave pump models 2000-5000



EcoWave Pond Pump Models				
	2000	3000	4000	5000
Item Number	91131	91132	91133	91134
Maximum Flow Rate	2,020 GPH / 7,500 LPH	2,960 GPH / 11,000 LPH	4,000 GPH / 15,000 LPH	5,000 GPH / 18,500 LPH
Maximum Head Height	14.4' (4.4 m)	17.5' (5.3 m)	20' (6 m)	21' (6.4 m)
Motor Type	Mag-Drive			
Wattage	65	90	130	150
Amperage	0.54	.75	1.08	1.25
Pump Discharge Diameter	2" MPT			
Pump Dimensions	11"L x 5.75"W x 7.5"H			
Packaged Weight	10.25 lb. (4.6 kg)	11.5 lb. (5.2 kg)	13 lb. (5.9 kg)	14 lb. (6.4 kg)
Packaged Dimensions	13"L x 11"W x 10.5"H	13"L x 11"W x 11.75"H	13"L x 11"W x 13"H	13"L x 11"W x 14"H

EcoWave Pond Pump Flow Chart (GPH)

Model	Max Head Height	Application Head Height										
		0'	2.5'	5'	7.5'	10'	12.5'	15'	17.5'	20'	22.5'	25'
2000	14.4'	2020	1350	860	650	400	150	0GPH				
3000	17.5'	2960	2150	1470	1100	850	550	300	0	GPH		
4000	20'	4000	2950	2210	1650	1250	1000	750	400	0	GPH	
5000	21'	5000	4050	3205	2450	1850	1450	1100	750	300	0 GPH	

BEST Operating Zone
 MAXIMUM Operating Zone

P AquaForce® Solids-Handling Pond Pump

Protective Cage

Prevents large debris from clogging or damaging pump, reducing maintenance



Smart Pump Receiver

Connects to the Aquascape Smart Control App, allowing you to control the pump with your smartphone or tablet

(For use with the AquaForce Adjustable Flow Solids-Handling Pond Pump only)



Powerful and Efficient Motor

Asynchronous motor technology makes this pump more powerful and more efficient than traditional "mag-drive," or magnetically driven pond pumps



Threaded Disconnect

Allows for the pump to be easily removed from the pond for maintenance or winterization without removing hose clamps or plumbing assembly

AquaForce 4000-8000 Adjustable Flow Solids-Handling Pond Pump Shown



Universal Remote for Adjustable Flow Pumps

- For use with adjustable flow pumps only

Packaged Weight: .3 lb. (.13 kg)

Packaged Dimensions: 5"L x 2.75"W x 1.25"H

#45041

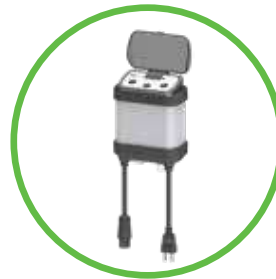

Smart Pump Receiver

- Upgrade your older model adjustable flow pump with a new Smart Pump Receiver

Packaged Weight: 1.5 lb. (.68 kg)

Packaged Dimensions: 8.5"L x 5.5"W x 4.5"H

#45064



Adjustable Flow Pump Extension Cord

- Extend pumps 25' from the receiver
- For use with adjustable flow pumps only

Packaged Weight: 2 lb. (0.9 kg)

Packaged Dimensions: 14"L x 4.25"W x 4.25"H

#45048



AquaForce Solids-Handling Pump Models

	1000	1800	2700	3600	5200	Adjustable Flow 4000-8000
Item Number	91011	91112	91012	91113	91013	91104
Maximum Flow Rate	1,070 GPH	2,149 GPH	2,695 GPH	3,868 GPH	5,284 GPH	7,793 GPH
	4,000 LPH	8,000 LPH	10,000 LPH	14,500 LPH	20,000 LPH	29,500 LPH
Maximum Head Height	10' (3 m)	16.5' (5 m)	14' (4.3 m)	18' (5.5 m)	24' (7.3 m)	28' (8.5 m)
Motor Type	Asynchronous					
Wattage	55	160	147	215	360	500 to 660*
Amperage	0.51	1.33	1.25	1.8	3	5.5
Pump Discharge Diameter	1.5" MPT					
App/WiFi Connected	—					✓
Pump Dimensions	14"L x 14"W x 6.5"H					
Packaged Weight	11 lb. (5 kg)	12.25 lb. (5.6 kg)	12 lb. (5.4 kg)	14.5 lb. (6.6 kg)		18.5 lb. (8.4 kg)
Packaged Dimensions	14.25"L x 14.25"W x 9"H	14.25"L x 15.25"W x 9"H	14.25"L x 15.75"W x 9"H	14.25"L x 16.25"W x 9"H	14.25"L x 16.75"W x 9"H	14.25"L x 18.75"W x 9"H

*Wattage range depending on flow setting

AquaForce Pond Pump Flow Chart (GPH)

Model	Max Head Height	Application Head Height							
		0'	5'	10'	15'	20'	25'	30'	35'
1000	10'	1070	850	0	GPH				
1800	16.5'	2149	1806	1320	260	0	GPH		
2700	14'	2695	2425	1840	0	GPH			
3600	18'	3868	3613	3254	2100	0	GPH		
5200	24'	5284	5116	4250	3186	1500	0	GPH	
4000-8000	28'	7794	7150	6440	5320	3950	1800	0	GPH

BEST Operating Zone
 MAXIMUM Operating Zone



Locking Knob
Convenient for quick and easy cage removal

Mag-Drive Motor
Makes this pump energy efficient and simple to maintain



Fittings included with 400/550/800



Fittings included with 1100/1500/2000



Ultra 1100 Water Pump Shown

Stable
The wide, flat base and rubber feet make the pump stable and reduces vibration



Small Ultra Pump Fountain Head Kit

- Ideal for Ultra 400, 550, and 800

Packaged Weight: .5 lb. (.23 kg)
Packaged Dimensions: 5.5"L x 3.5"W x 7.25"H
#91045



Large Ultra Pump Fountain Head Kit

- Ideal for Ultra 1100, 1500, and 2000

Packaged Weight: .5 lb. (.23 kg)
Packaged Dimensions: 6"L x 3"W x 9"H
#91046

Included fittings integrate seamlessly into Aquascape AquaBasin®

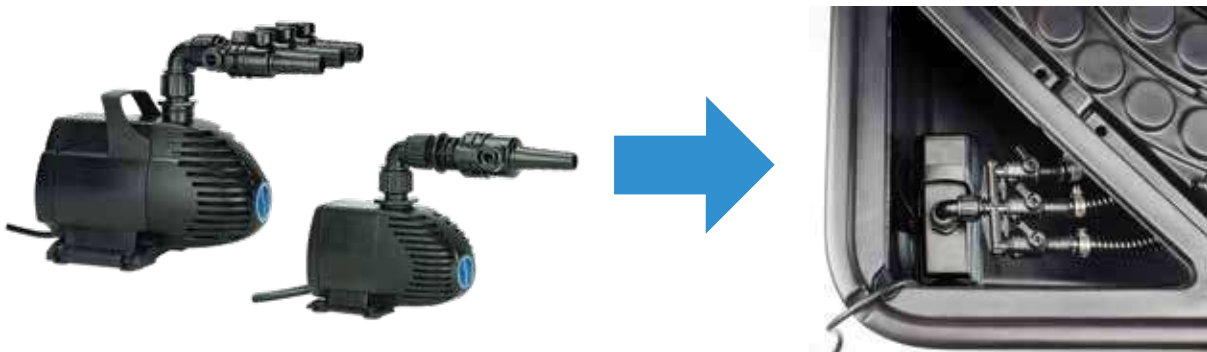

K | F | P | A | L | P A | W T | S C | F P C | D | L U G | P P | I T



Ultra Water Pump Models						
	400	550	800	1100	1500	2000
Item Number	91005	91006	91007	91008	91009	91010
Maximum Flow Rate	370 GPH 1,000 LPH	528 GPH 1,500 LPH	793 GPH 3,000 LPH	1,110 GPH 4,000 LPH	1,480 GPH 5,500 LPH	1,982 GPH 7,500 LPH
Maximum Head Height	7.5' (2.3 m)	8' (2.4 m)	9' (2.7 m)	12' (3.6 m)	16.5' (5 m)	20' (6 m)
Motor Type	Mag-Drive					
Wattage	24	33	58	92	153	250
Amperage	0.40	0.55	0.80	0.85	1.46	2.60
Pump Discharge Diameter	1/2", 3/4", 1", and 1.25"					
Pump Dimensions	5"L x 3"W x 3.25"H	6"L x 3.35"W x 4"H		7.5"L x 3.7"W x 5"H	9"L x 5.25"W x 7"H	
Packaged Weight	2.5 lb. (1 kg)	3 lb. (1.4 kg)	4.5 lb. (2 kg)	5.25 lb. (2.4 kg)	8 lb. (3.6 kg)	9 lb. (4 kg)
Packaged Dimensions	9"L x 5"W x 5"H	9"L x 5.25"W x 5.25"H	9"L x 6.5"W x 6"H	9.5"L x 6.75"W x 7"H	10.5"L x 8"W x 8"H	10.5"L x 8"W x 9"H

Ultra Water Pump Flow Chart (GPH)

Model	Max Head Height	Application Head Height									
		0'	2.5'	5'	7.5'	10'	12.5'	15'	17.5'	20'	22.5'
400	7.5'	370	300	200	0	GPH					
550	8'	528	425	300	75	0	GPH				
800	9'	793	675	500	275	0	GPH				
1100	12'	1110	1000	800	600	300	0	GPH			
1500	16.5'	1480	1350	1200	1050	825	575	200	0	GPH	
2000	20'	1985	1875	1750	1600	1375	1125	800	450	0	GPH

BEST Operating Zone
 MAXIMUM Operating Zone

P AquaJet® Pond Pump and Pond Powerhead

The AquaJet Pond Pump is a submersible pump with an integrated fountain, ideal for small to medium ponds. It provides efficient water circulation while creating an attractive fountain display with multiple nozzle options.



AquaJet Pond Pump Models

	600	1300	2000
Item Number	91014	91015	91016
Pond Size Recommendation	1,200 gal. / 4,800 L	1,300 gal. / 5,200 L	2,000 gal. / 8,000 L
Maximum Fountain Height (Daisy Fountain)	Up to 47"	Up to 62"	Up to 65"
Motor Type	Mag-Drive		
Wattage	33	110	250
Amperage	0.55	1.00	2.60
Pump Discharge Diameter on Diverter	1/2", 3/4"		1/2", 3/4", 1"
Pump Dimensions	12"L x 12"W x 6"H		
Packaged Weight	6.5 lb. (2.9 kg)	9 lb. (4 kg)	9.5 lb. (4.3 kg)
Packaged Dimensions	13"L x 9"W x 14"H	13.25"L x 8.75"W x 15"H	13.25"L x 9"W x 15.75"H

The **Pond Powerhead** is designed to create water movement and eliminate stagnant areas in ponds and water gardens, providing circulation, surface agitation, and aeration. This standalone pump does not require any pipe or plumbing.



Pond Powerhead

- Maximum flow rate of 2,000 GHP/7,647 LPH
 - 40 Watt, 12 Volt
 - Mag-Drive Motor
 - 3.33 Amps, 60 Hz Frequency
- Packaged Weight: 9.5 lb.

Packaged Dimensions: 13.25"L x 9"W x 15.75"H

#91142

Transformer not included - must use a transformer greater than 40-watts, see page 64

The statuary pumps are compact, energy-efficient pumps designed for small decorative features like tabletop fountains and spitters.

Mag-Drive Motor

Makes this pump energy efficient and simple to maintain



Flow Control

Allows you to create a customized water flow

Intake Strainer

Prevents the pump from running dry or pulling in air in shallow applications

90 GPH Water Pump Shown



Statuary Water Pump Models

	70	90	180	320
Item Number	91023	91024	91025	91026
Maximum Flow Rate	70 GPH / 250 LPH	90 GPH / 300 LPH	180 GPH / 650 LPH	320 GPH / 1,200 LPH
Maximum Head Height	2' (0.6 m)	3' (0.9 m)	4' (1.2 m)	5.5' (1.7 m)
Motor Type	Mag-Drive			
Wattage	3.0	4.3	9.3	17.6
Amperage	.037	.061	.175	.339
Pump Discharge Diameter	1/2", 5/8"			
Pump Dimensions	2"L x 1.5"W x 1.25"H	2.5"L x 1.75"W x 2"H	3"L x 2.5"W x 2"H	4"L x 3.25"W x 2.5"H
Packaged Weight	.75 lb. (340 g)		1.25 lb. (0.6 kg)	2 lb. (0.9 kg)
Packaged Dimensions	4"L x 4"W x 2.75"H	4.25"L x 4"W x 3.25"H	4"L x 4"W x 4"H	4"L x 4"W x 4.75"H



	Pump Cleaner Maintenance Solution	LSR Cleanout Pump	Cleanout Pump Discharge Hose 50'
Item Number	91143	45063	48019
Packaged Weight	.75 lb. (340 g)	28 lb. (12.7 kg)	14.75 lb. (6.7 kg)
Packaged Dimensions	8 oz. bottle	9.25"L x 9.25"W x 11.38"H	22.5"L x 22.5"W x 9"H

The Pump Cleaner Maintenance Solution uses cutting-edge cleaning compounds to remove scale and biofilm to restore the pump. **#91143**

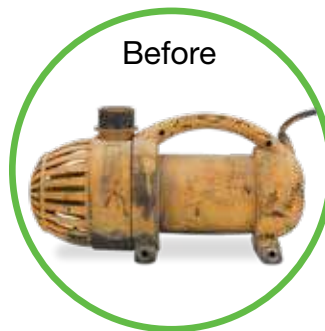

Pond Aeration



4-Outlet Pond Aeration Kit



ProAir 60 Pond Aeration Kit



Every biological process that occurs in ponds is dependent on oxygen. This is especially important in warmer temperatures or at night when plants are not converting sunlight into oxygen. Pond aerators supply dissolved oxygen directly to ponds and other water features, helping all biological processes and resulting in healthier fish and plants.

Quiet Operation

Rubber feet and internal gasket prevents noise and vibration

Durability

Strong outer housing protects the pump from becoming damaged



4-Outlet Pond Aeration Kit Shown

Weighted Aeration Disks

Provide ideal air flow for ponds and water gardens



	2-Outlet Pond Aeration Kit	4-Outlet Pond Aeration Kit
Item Number	75000	75001
Pond Size	Up to 2,000 gal. / 7,570 L	Up to 3,500 gal. / 13,428 L
Maximum Recommended Pond Depth	8.5' (2.6 m)	9' (2.7 m)
Maximum Air Flow Rate (Loaded)	0.28 CFM (8 L/min)	0.49 CFM (14 L/min)
Maximum Air Depth (Loaded)	3.70 psi (0.26 kgf/cm2)	3.98 psi (0.28 kgf/cm2)
Number of Aeration Discs	2	4
Wattage	6	11
Check Valve	Included and pre-installed	
Power Cord Length	6'	
Airline Length	(2) 25' Rolls 3/16" Silicone	(4) 25' Rolls 3/16" Silicone
Pump Dimensions	5.25"L x 4.75"W x 3.5"H	7.75"L x 7.25"W x 6.25"H
Packaged Weight	3.5 lb. (1.6 kg)	6.25 lb. (2.8 kg)
Packaged Dimensions	15.5"L x 4"W x 12"H	17.75"L x 5.5"W x 11.75H



Pond Aerator Aeration Disc

Packaged Weight: .5 lb. (.23 kg)

Packaged Dimensions: 5"L x 9"W x 1"H

#75005



	Pro Air 20	Pro Air 60
Item Number	61009	61008
Pond Size	Up to 5,000 gal. / 20,000 L	Up to 15,000 gal. / 60,000 L
Maximum Recommended Pond Depth	6.5' (2 m)	11.5' (3.5 m)
Maximum Air Flow Rate (Loaded)	0.71 CFM (20 L/min)	2.1 CFM (60 L/min)
Maximum Air Depth (Loaded)	2.90 psi (0.20 kgf/cm ²)	5.08 psi (0.36 kgf/cm ²)
Number of Outlets	1	2 (Includes 2-Way Manifold)
Number of Diffusers	1	2
Wattage	15	45
Check Valve	Included and pre-installed	
Power Cord Length	6'	
Airline Length	(1) 30' Roll 3/8" Braided Vinyl	(2) 30' Roll 3/8" Braided Vinyl
Pump Dimensions	6"L x 5.5"W x 4.25"H	7.75"L x 7.25"W x 6.25"H
Aeration Diffuser Dimensions	10"L x 4"H	
Packaged Weight	11.5 lb. (5.2 kg)	22 lb. (10 kg)
Packaged Dimensions	12"L x 11"W x 10"H	14.25"L x 12.75"W x 9"H



Pro Air 20 Aeration Compressor

Packaged Weight:
5.75 lb. (2.6 kg)
Packaged Dimensions:
8.75"L x 7.5"W x 7"H
#61017



Pro Air 60 Aeration Compressor

Packaged Weight:
11.5 lb. (5.2 kg)
Packaged Dimensions:
9.5"L x 7.75"W x 8.25"H
#61016



Weighted Aeration Tubing 3/8" x 25'

Packaged Weight:
7.3 lb. (3.3 kg)
Packaged Dimensions:
13"L x 13"W x 4.75"H
#61011



Weighted Aeration Tubing 3/8" x 100'

Packaged Weight:
32 lb. (14.5 kg)
Packaged Dimensions:
18"L x 14"W x 9"H
#61014

Pond and Landscape Lighting



Warm White Lights



Color-Changing Lights



Landscape Lighting



The complete line of Aquascape LED pond lights and garden lighting makes it easy to enjoy your water feature.

K | F | P | A | L | P A | W T | S C | F P C | D | L U G | P P | I T



NEW

Precisely Engineered

Strategically angled LEDs, paired with a curved optical lens, concentrate maximum light output into the fountain's water column



Die-Cast Metal

Fully sealed, water-tight construction for long-lasting, weather-resistant use

Quick and Easy Installation

Fully integrated quick connect fitting



Large Fountain Light

Item Number	84079	Bulb Life	50,000 Hours
Lumens	300 lm	12V Quick-Connect Fitting	✓
Wattage	6W±10%	Cord Length	25' (7.6 m)
Voltage Min-Max	10.8V – 15V	Light Dimensions	4.2" Dia. x 1.45" H
Temperature in Kelvin	3,000 K	Packaged Weight	2 lb.
Color Rendering Index (CRI)	70	Packaged Dimensions	6.5"L x 3.8"W x 7.7"H

The Large Fountain Light is designed to be used with the Convertible Fountain Fitting included with most Aquascape decorative fountains.



Easily installs into fountains with 3/4" tubing and an Aquascape fountain fitting



For more water flow, use 1-1/2" PVC pipe to secure the Large Fountain Light

K | F | P | A | L | P A | W T | S C | F P C | D | L U G | P P | I T



Pond and Landscape LED Lights

	1-Watt Waterfall Light	1-Watt Spotlight	3-Watt Spotlight	6-Watt Spotlight	8-Watt Wide-Angle Light
Item Number	84032	84031	84033	84034	84077
Lumens	45 lm		150 lm	340 lm	840 lm
Wattage	1.2W±10%		3W±10%	5.8W±10%	8W±10%
Voltage Min-Max	9V – 15V				10.8V – 15V
Temperature in Kelvin	3,000 K				
Color Rendering Index (CRI)	75				70
Beam Angle Spread	30°				90°
Bulb Life	40,000 Hours				50,000 Hours
Fixture Material	Die-Cast Metal				
Cord Length	14.5'				25'
Stake and Stand Included	–	✓			Sold Separately
Light Dimensions	2" Dia. x 1.5"H	1.25" Dia. x 2"H	3" Dia. x 3"H		2.7"L x 3.8"W x 2.9"H
Packaged Weight	1 lb. (453 g)		2.5 lb. (1.1 kg)	2.75 lb. (1.2 kg)	2.53 lb. (1.1 kg)
Packaged Dimensions	4.75"L x 4.5"W x 7.5"H	4.75"L x 3.75"W x 11"H	5"L x 5"W x 13"H	6.25"L x 6"W x 14"H	5.27"L x 5.27"W x 4.37"H

Note: All pond and landscape lights require 12V transformer

! Only for use with the Universal Mount Adapter on the wide-angle light

**Light Stake**

Packaged Weight:
0.3 lb. (136 g)
Packaged Dimensions:
5"L x 10.5"W x 3"H
#84080

**Flexible Light Stand**

Packaged Weight:
0.4 lb. (181 g)
Packaged Dimensions:
10.75"L x 13"W x 1"H
#84081

Available in a 6-Pack!



- 1-Watt Waterfall Light 6-Pack
#84046
- 1-Watt Spotlight 6-Pack
#84045

- 3-Watt Spotlight 6-Pack
#84047
- 6-Watt Spotlight 6-Pack
#84048

K | F | P | A | L | P A | W T | S C | F P C | D | L U G | P P | I T

Warm White Fountain Lights and Cables



	LED Fountain Light	Fountain Light Kit with Transformer
Item Number	84008	84009
Lumens	24 lm	
Wattage	2.5W±10%	
Voltage Min-Max	10.8V – 15V	
Temperature in Kelvin	3,000 K	
Color Rendering Index (CRI)	70	
Beam Angle Spread	30°	
Bulb Life	40,000 Hours	
12V Quick-Connect Fitting	✓	
Fixture Material	Plastic	
Cord Length	15' (4.6 m)	
Light Dimensions	1.5" Dia. x 2.5"H	
Acceptable Pipe Diameter	1/2" – 3/4"	
Packaged Weight	1 lb. (453 g)	2 lb. (0.9 kg)
Packaged Dimensions	2.75"L x 2.5"W x 8.25"H	5.5"L x 2.5"W x 7.25"H

Note: All pond and landscape lights require 12V transformer



	25' Quick-Connect Extension Cable	25' 5-Outlet Quick-Connect Extension Cable	3-Way Quick-Connect Splitter	6-Way Quick-Connect Splitter
Item Number	98998	84023	98489	84022
Quick-Connect Connections	1	5	3	6
Type of Quick-Connect	2-Pin			
Cord Length	25' (7.6 m)		8" (20.3 cm)	36" (91.4 cm)
Packaged Weight	1 lb. (.45 kg)		.5 lb. (.23 kg)	.75 lb. (340 g)
Packaged Dimensions	5.75"L x 2.75"W x 5.75"H		2.5"L x 1.5"W x 3.75"H	8"L x 8"W x 2"H



Quick-Connect Photocell with Timer

Automatically turns Aquascape lights on at dusk and off at dawn or after 4, 6, or 8 hours. It features built-in memory, supports up to 60 watts, and integrates easily with other 12-volt quick-connect components.

Packaged Weight: .75 lb.

Packaged Dimensions: 2"L x 1.25"W x 3.25"H with a 36" cord

#84039

K | F | P | A | L | P | A | W | T | S | C | F | P | C | D | L | U | G | P | P | I | T

3-Light Spotlight Kit



3-Light Spotlight Kit

Item Number	84030
Lumens	140
Wattage	3
Temperature in Kelvin	3,000 K
Bulb Life	40,000 Hours
Cord Length	15'
Packaged Weight	4 lb. (1.8 kg)
Packaged Dimensions	16.5"L x 3.5"W x 12"H

3-Light Spotlight Kit Includes



Three pre-wired
1-watt LED lighting
fixtures



Adjustable stands and
landscape stakes



6-watt/12 V
transformer



Pond and Landscape
Quick-Connect
Photocell with Timer



LED Color-Changing Lights

	2-Watt Color-Changing Waterfall Light	4.5-Watt Color-Changing Spotlight	8-Watt Color-Changing Spotlight	Color-Changing Wide-Angle Light 11-Watt
Item Number	84057	84059	84060	84076
Lumens	52 lm / White	128 lm / White	223 lm / White	640 lm / White
Wattage	2W±10%	4.5W±10%	8W±10%	11W±10%
Voltage Min-Max	10.8V – 15V			
Temperature in Kelvin	3,000 K			
Color Rendering Index (CRI)	70 / White			
Beam Angle Spread	30°		90°	
Bulb Life	40,000 Hours		50,000 hours	
12V Quick-Connect Fitting	✓			
Fixture Material	Die-Cast Metal			
Smart Control Hub #84074 Required (Sold Separately)	✓			
Cord Length	15'		25'	
Stake and Stand Included	—	✓		Sold Separately
Light Dimensions	2" Dia. x 1.5"H	3" Dia. x 3"H		2.7"L x 3.8"W x 2.9"H
Packaged Weight	1.25 lb. (.56 kg)	2.75 lb. (1.2 kg)		2.53 lb. (1.1 kg)
Packaged Dimensions	4.75"L x 4.5"W x 7.5"H	5.25"L x 5.25"W x 13.25"H	6.25"L x 6.25"W x 16.25"H	5.27"L x 5.27"W x 4.37"H

! Color-changing lights require a Smart Control Hub and 12V transformer

! Only for use with the Universal Mount Adapter on the wide-angle light

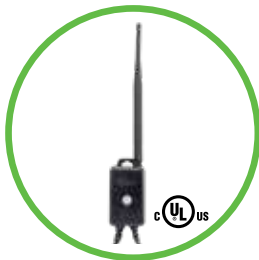

Smart Control Hub

Packaged Weight: .75 lb. (340 g)

Packaged Dimensions: 4.75"L x 2"W x 4.75"H

#84074



12V Transformers

See page 64



Light Stake

Packaged Weight: 0.3 lb. (136 g)

Packaged Dimensions: 5"L x 10.5"W x 3"H

#84080



Flexible Light Stand

Packaged Weight: 0.4 lb. (181 g)

Packaged Dimensions: 10.75"L x 13"W x 1"H

#84081

K | F | P | A | L | P | A | W | T | S | C | F | P | C | D | L | U | G | P | P | I | T

Color-Changing Fountain Lights



	Color-Changing Fountain Light	Color-Changing Fountain Light Kit Note: All-in-one kit, not WiFi compatible
Item Number	84072	84055
Lumens	20 lm / White	
Wattage	2W±10%	
Voltage Min-Max	10.8V – 15V	
Temperature in Kelvin	3,000 K	
Color Rendering Index (CRI)	70 / White	
Beam Angle Spread	30°	
Bulb Life	40,000 Hours	
Fixture Material	Plastic	
Includes Required Transformer	–	✓
Smart Control Hub #84074 Required (Sold Separately)	✓	Not compatible
Cord Length	15'	
Light Dimensions	1.5 in Dia. x 2.5 in H	
Acceptable Pipe Diameter	1/2" – 3/4"	
Packaged Weight	0.5 lb. (226 g)	2.25 lb. (1 kg)
Packaged Dimensions	3.75"L x 1.75"W x 8.25"H	5.5"L x 2.75"W x 7.75"H



Color-Changing Light Extension Cables

L



	25' Color-Changing Light Extension Cable	25' 5-Outlet Color-Changing Light Extension Cable	3-Way Color-Changing Light Splitter	6-Way Color-Changing Light Splitter
Item Number	84069	84070	84062	84068
Quick-Connect Connections	1	5	3	6
Type of Quick-Connect	4-Pin			
Cord Length	25'		12"	12"
Packaged Weight	1.25 lb. (.56 kg)	1.5 lb. (.68 kg)	.25 lb. (.11 kg)	.75 lb. (340 g)
Packaged Dimensions	7.25"L x 1.75"W x 5.75"H	7"L x 2.5"W x 6.25"H	4"L x 1.5"W x 3"H	7.25"L x 1.75"W x 2"H



K | F | P | A | L | PA | WT | SC | FPC | D | LUG | PP | IT



Path and Area Landscape Lights

	Hat Top	Dome Top
Item Number	84063	84064
Lumens	270 lm	
Wattage	3W±10%	
Voltage Min-Max	9V – 15V	
Temperature in Kelvin	2,700 K	
Color Rendering Index (CRI)	80	
Beam Angle Spread	120°	90°
Bulb Life	25,000 Hours	
Fixture Material	Brass	
Cord Length	3' (.91 m)	
Light Dimensions	6.5" Dia. x 18.25"H	
Packaged Weight	1.75 lb. (.79 kg)	
Packaged Dimensions	5.75"L x 5.75"W x 9.25"H	

Note: All path and area landscape lights require 12V transformer



Durable Brass Construction

Antique bronze finish

LED Bulb

Energy-efficient, long-lasting
3-watt bulb



Acrylic Lens

Protects LED bulb from outdoor elements



Sealed Wire Exit

Prevents moisture and insects from entering

Available in a 6-Pack!



- Hat Top Path and Area Landscape Light 6-Pack
[#84065](#)
- Dome Top Path and Area Landscape Light 6-Pack
[#84066](#)

Power Accessories



Transformers



Smart Control Plug



Aquascape offers a variety of power accessories, including an array of low voltage transformers and a WiFi-enabled Smart Control Plug. Use the transformers to power low-voltage lighting or low-voltage accessories and control them all with the Smart Control Plug using the Aquascape Smart Control App on your smartphone or tablet.



Low Voltage Transformers

	6-Watt	20-Watt	60-Watt	60-Watt with Photocell	150-Watt with Photocell
Item Number	98375	98485	98486	99070	01002
Quick-Connect Connections	1				3
Type of Quick-Connect	2-Pin				
Photocell Included	—			✓	
Transformer Dimensions	3"L x 1.5"W x 2.25"H	4"L x 1.75"W x 2.5"H	3"L x 6"W x 3"H	3.5"L x 7"W x 2.5"H	47"L x 7"W x 3.5"H
Packaged Weight	1 lb. (453 g)	1.75 lb. (.79 kg)	3.5 lb. (1.6 kg)	4 lb. (1.8 kg)	8 lb. (3.6 kg)
Packaged Dimensions	6.5"L x 3"W x 4.5"H	6.25"L x 2"W x 4"H	6"L x 2"W x 4"H	8.75"L x 7.5"W x 4.25"H	7.75"L x 4"W x 4"H



Smart Control Plug



Smart Control Plug

Allows you to control and monitor outdoor electronics from anywhere with your smartphone or tablet using the Aquascape Smart Control App.

- WiFi pairing button/indicator allows for quick and easy connection to your smartphone or tablet
- Integrated hang tag provides secure mounting option
- Numbered outlets allow simple, clear setup
- Waterproof caps protects unit when not in use

Packaged Weight: .5 lb. (.23 kg)

Dimensions: 6"L x 1.5"W x 5.5"H with 6" cord

Packaged Dimensions: 7"L x 2"W x 6"H

#82001

Water Treatments

Simple
Solutions

Beneficial
Bacteria

Sludge
Fighting

Water
Conditioners

Algae
Fighting

Problem
Solving

Fountain

Lake and
Large Pond

Aquascape has a variety of options to clean and maintain your pond, waterfall or fountain. Select from simple solutions, beneficial bacteria, problem solving, algae fighting, water conditioners, sludge fighting, fountain treatments, and lake and large pond treatments.

K | F | P | A | L | P A | W T | S C | F P C | D | L U G | P P | I T

Aquascape Simple Solutions Water Treatments Are Designed to Make Your Life Easier!

By combining our best water treatments into four treatments for ponds and two for waterfalls and fountains, we have a solution for the most common water feature issues. Choose a simple pump top or use the dosing system versions and prepare to be amazed at the results.

Maintain for Ponds	Clear for Ponds
<p>Staple water treatment for ponds, designed to keep ponds clean and healthy</p> <p>What It Does</p> <ul style="list-style-type: none"> • Reduces maintenance • Supports a healthy ecosystem • Provides healthy and crystal-clear water conditions <p>How It Works</p> <ul style="list-style-type: none"> • Combines our most effective water treatments into one powerful formulation (like a multivitamin) • Uses a beneficial bacteria blend, phosphate binder, flocculant clarifier, and detoxifier 	<p>Use to clear unsightly water conditions, including cloudy and discolored water</p> <p>What It Does</p> <ul style="list-style-type: none"> • Clarifies water and resolves water quality problems • Mitigates cloudy or discolored water and issues with debris attached to rocks and gravel <p>How It Works</p> <ul style="list-style-type: none"> • Uses a concentrated formula of clarifiers and a phosphate binder which work to prevent and eliminate issues with water clarity and debris buildup
Clean for Ponds	Protect for Ponds
<p>Use to naturally reduce organic sludge and debris</p> <p>What It Does</p> <ul style="list-style-type: none"> • Reduces organic waste caused by uneaten fish food, fish waste, and leaves or debris • Naturally cleans rocks, gravel, and filters • Keeps ponds looking clean and clear <p>How It Works</p> <ul style="list-style-type: none"> • Uses a powerful blend of heterotrophic bacteria to digest organic waste and sludge 	<p>Use to protect pond fish such as koi and goldfish. Great for use after transporting/handling fish or cleanouts.</p> <p>What It Does</p> <ul style="list-style-type: none"> • Reduces fish stress • Prevents parasites and infections • Accelerates healing of superficial wounds, scrapes and breeding abrasions <p>How It Works</p> <ul style="list-style-type: none"> • Uses an all-natural formulation of tea tree oil and other plant-based biopolymers
Prevent for Fountains	Clean for Fountains
<p>Staple product for fountains; cleans and clarifies</p> <p>What It Does</p> <ul style="list-style-type: none"> • Controls white-scale buildup, foam, and stains • Helps to clear unsightly water conditions and debris that attaches to surfaces <p>How It Works</p> <ul style="list-style-type: none"> • Contains a special blend of clarifiers and scale remover that will not damage fountain surface <p>Note: Not for use with water features containing fish</p>	<p>Used to clear unsightly suspended debris</p> <p>What It Does</p> <ul style="list-style-type: none"> • Keeps waterfalls and fountains clean, clear, and healthy • Reduces maintenance and improves water quality <p>How It Works</p> <ul style="list-style-type: none"> • Uses a flocculant clarifier and phosphate binder to help clear and prevent debris

Simple Solution treatments can be used three different ways.



The Smart Pond Dosing System XT

Ideal for ponds, waterfalls, and fountains up to 75,000 gallons



The Dosing System SL

Ideal for ponds, waterfalls, and fountains up to 2,250 gallons



Manually with Pump Top Versions

Available in four sizes for ponds, waterfalls, and fountains from 100 to 80,000 gallons

Ideal for Ponds, Waterfalls, and Fountains Up to 75,000 Gallons

Durable Enclosure

Stores up to a gallon of treatment for longer durations between refills

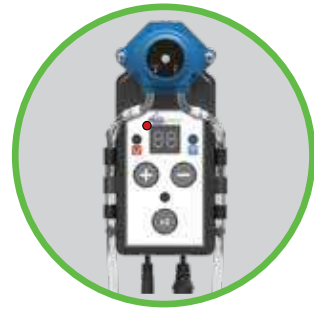
**Mounted Controller**

Push-button design makes it easy to set for your water feature size

Smart Control

Connect to the app to control, monitor, and receive alerts on your smartphone or tablet

**Smart Pond Dosing System XT**

- Treats larger water features with ease (30,000 gallons for over a month)

Includes: enclosure, (1) control panel, (1) treatment intake with low treatment alert, internal and external treatment tubing, and low-voltage transformer

Controller Wattage: 6W

Transformer Wattage: 12W

Volts: 12V

Cord Length: 13 ft.

Tubing Length: 6 ft.

Packaged Weight: 6 lb.

Packaged Dimensions: 11.5"L x 9.75"W x 15.25"H

#40040

Low-Treatment Alert

Alerts you when the treatment is 90% empty

Add Two Different Treatments Simultaneously!**Smart Pond Dosing System Controller Add-On Kit**

- Add to Smart Pond Dosing System XT to dose two 64 oz. treatments simultaneously
- Includes intake assembly, tubing, and power cable

Packaged Weight: .75 lb. (340 g)

Packaged Dimensions: 11"L x 4.75"W x 3.75"H

#40042

XT Water Treatments for Ponds and Fountains

Designed only for use with the Smart Pond Dosing System XT.

Maintain for Ponds

Item Number	40048	40049	40032	40033
Concentration	Standard 1X		3X	
Package Size	64 oz. / 1.89 L	1 gal. / 3.78 L	64 oz. / 1.89 L	1 gal. / 3.78 L
Packaged Weight	4.4 lb. (2 kg)	8.7 lb. (3.9 kg)	4.4 lb. (2 kg)	8.7 lb. (3.9 kg)



Clear for Ponds

Item Number	40050	40051	40034	40035
Concentration	Standard 1X		3X	
Package Size	64 oz. / 1.89 L	1 gal. / 3.78 L	64 oz. / 1.89 L	1 gal. / 3.78 L
Packaged Weight	4.4 lb. (2 kg)	8.7 lb. (3.9 kg)	4.4 lb. (2 kg)	8.7 lb. (3.9 kg)



Clean for Ponds

Item Number	40052	40053	40036	40037
Concentration	Standard 1X		3X	
Package Size	64 oz. / 1.89 L	1 gal. / 3.78 L	64 oz. / 1.89 L	1 gal. / 3.78 L
Packaged Weight	4.4 lb. (2 kg)	8.7 lb. (3.9 kg)	4.4 lb. (2 kg)	8.7 lb. (3.9 kg)



Protect for Ponds

Item Number	40054	40055	40038	40039
Concentration	Standard 1X		3X	
Package Size	64 oz. / 1.89 L	1 gal. / 3.78 L	64 oz. / 1.89 L	1 gal. / 3.78 L
Packaged Weight	4.4 lb. (2 kg)	8.7 lb. (3.9 kg)	4.4 lb. (2 kg)	8.7 lb. (3.9 kg)



Prevent for Fountains and Waterfalls

Item Number	40056	40057	40058	40059
Package Size	64 oz. / 1.89 L	1 gal. / 3.78 L	64 oz. / 1.89 L	1 gal. / 3.78 L
Packaged Weight	4.4 lb. (2 kg)	8.7 lb. (3.9 kg)	4.4 lb. (2 kg)	8.7 lb. (3.9 kg)

Clean for Fountains and Waterfalls



Ideal for Ponds, Waterfalls, and Fountains up to 2,250 Gallons

Hood Design

Designed to hide and protect mounted control panels from weather conditions

Easy-to-Use Controller

Simply set for your water feature size and enjoy the benefits



Compact Design

Sleek and compact to easily hide near smaller water features

Storage Capacity

Store up to 32 oz. of water treatment

Dosing System SL

- Treats smaller water features up to 2,250 gallons
- Includes: enclosure, control panel, treatment intake, internal and external tubing, and low-voltage transformer
- Controller Wattage: 4.5W
 Transformer Wattage: 6W
 Cord Length: 13 ft. (4.3 m)
 Tubing Length: 6 ft. (2 m)
 Packaged Weight: 3 lb. (1.4 kg)
 Packaged Dimensions: 6"L x 4"W x 10"H

#96085

Durable Housing

Built to last and can be partially buried to conceal

SL Water Treatments for Ponds and Fountains

Designed for use with the Dosing System SL and the Automatic Dosing System



	Maintain for Ponds	Clear for Ponds	Clean for Ponds	Protect for Ponds	Prevent for Fountains and Waterfalls	Clean for Fountains and Waterfalls
Item Number	96090	96091	96092	96093	96094	96095
Package Size	32 oz. / 946 ml					
Packaged Weight	2.5 lb. (1.1 kg)					

Maintain for Ponds

Item Number	96057	96058	96059	96060
Package Size	8 oz. / 236 ml	16 oz. / 473 ml	32 oz. / 946 ml	1 gal. / 3.78 L
1 Pump Treats	100 gal. / 378 L			600 gal. / 2,268 L
1 Bottle Treats	5,000 gal. / 18,900 L	10,000 gal. / 37,800 L	20,000 gal. / 75,600 L	80,000 gal. / 302,400 L
Packaged Weight	.75 lb. (340 g)	1.25 lb. (.56 kg)	2.5 lb. (1.1 kg)	8 lb. (3.6 kg)



Clear for Ponds

Item Number	96065	96066	96067	96068
Package Size	8 oz. / 236 ml	16 oz. / 473 ml	32 oz. / 946 ml	1 gal. / 3.78 L
1 Pump Treats	100 gal. / 378 L			600 gal. / 2,268 L
1 Bottle Treats	5,000 gal. / 18,900 L	10,000 gal. / 37,800 L	20,000 gal. / 75,600 L	80,000 gal. / 302,400 L
Packaged Weight	.75 lb. (340 g)	1.25 lb. (.56 kg)	2.5 lb. (1.1 kg)	8 lb. (3.6 kg)



Clean for Ponds

Item Number	96061	96062	96063	96064
Package Size	8 oz. / 236 ml	16 oz. / 473 ml	32 oz. / 946 ml	1 gal. / 3.78 L
1 Pump Treats	100 gal. / 378 L			600 gal. / 2,268 L
1 Bottle Treats	5,000 gal. / 18,900 L	10,000 gal. / 37,800 L	20,000 gal. / 75,600 L	80,000 gal. / 302,400 L
Packaged Weight	.75 lb. (340 g)	1.25 lb. (.56 kg)	2.5 lb. (1.1 kg)	8 lb. (3.6 kg)



Protect for Ponds

Item Number	96069	96070	96071	96072
Package Size	8 oz. / 236 ml	16 oz. / 473 ml	32 oz. / 946 ml	1 gal. / 3.78 L
1 Pump Treats	100 gal. / 378 L			600 gal. / 2,268 L
1 Bottle Treats	5,000 gal. / 18,900 L	10,000 gal. / 37,800 L	20,000 gal. / 75,600 L	80,000 gal. / 302,400 L
Packaged Weight	.75 lb. (340 g)	1.25 lb. (.56 kg)	2.5 lb. (1.1 kg)	8 lb. (3.6 kg)



Prevent for Fountains and Waterfalls

Item Number	96073	96074	96075	96076
Package Size	8 oz. / 236 ml	16 oz. / 473 ml	32 oz. / 946 ml	1 gal. / 3.78 L
1 Pump Treats	100 gal. / 378 L			600 gal. / 2,268 L
1 Bottle Treats	5,000 gal. / 18,900 L	10,000 gal. / 37,800 L	20,000 gal. / 75,600 L	80,000 gal. / 302,400 L
Packaged Weight	.75 lb. (340 g)	1.25 lb. (.56 kg)	2.5 lb. (1.1 kg)	8 lb. (3.6 kg)



Note: Not for use with water features containing fish

Clean for Fountains and Waterfalls

Item Number	96077	96078	96079	96080
Package Size	8 oz. / 236 ml	16 oz. / 473 ml	32 oz. / 946 ml	1 gal. / 3.78 L
1 Pump Treats	100 gal. / 378 L			600 gal. / 2,268 L
1 Bottle Treats	5,000 gal. / 18,900 L	10,000 gal. / 37,800 L	20,000 gal. / 75,600 L	80,000 gal. / 302,400 L
Packaged Weight	.75 lb. (340 g)	1.25 lb. (.56 kg)	2.5 lb. (1.1 kg)	8 lb. (3.6 kg)



Beneficial Bacteria

- Fast acting
- Contains 8 strains of bacteria including photosynthetic strains
- Contains marigold and vitamin B



Beneficial Bacteria				
Item Number	98886	98887	98888	98885
Package Size	8 oz. / 236 ml	16 oz. / 473 ml	32 oz. / 946 ml	1 gal. / 3.78 L
1 Pump Treats	100 gal. / 378 L			600 gal. / 2,268 L
1 Bottle Treats	5,000 gal. / 18,900 L	10,000 gal. / 37,800 L	20,000 gal. / 75,600 L	80,000 gal. / 302,400 L
Packaged Weight	.75 lb. (340 g)	1.25 lb. (.56 kg)	2.5 lb. (1.1 kg)	8 lb. (3.6 kg)

Beneficial Bacteria Concentrate

- Contains eight strains of bacteria including photosynthetic strains
- Contains marigold and vitamin B
- Ideal for larger ponds



Beneficial Bacteria Concentrate				
Item Number	98925	98948	98949	98950
Package Size	4.4 oz. / 125 g	8.8 oz. / 250 g	1.1 lb. / 500 g	7 lb. / 3.2 kg
1 Scoop Treats	1,300 gal. / 4,914 L			
1 Container Treats	26,000 gal. / 98,280 L	52,000 gal. / 196,560 L	104,000 gal. / 393,120 L	660,400 gal. / 2,499,886 L
Packaged Weight	.25 lb. (.11 kg)	.75 lb. (340 g)	1.25 lb. (.56 kg)	7.5 lb. (3.4 kg)

Cold Water Beneficial Bacteria

- Reduces ammonia, nitrite, and organic debris
- Ideal for use in water colder than 50°F (5°C)



Cold Water Beneficial Bacteria				
Item Number	98892	98893	98894	96021
Package Size	8 oz. / 236 ml	16 oz. / 473 ml	32 oz. / 946 ml	1 gal. / 3.78 L
1 Pump Treats	100 gal. / 378 L			600 gal. / 2,268 L
1 Bottle Treats	5,000 gal. / 18,900 L	10,000 gal. / 37,800 L	20,000 gal. / 75,600 L	80,000 gal. / 302,400 L
Packaged Weight	.75 lb. (340 g)	1.25 lb. (.56 kg)	2.5 lb. (1.1 kg)	8 lb. (3.6 kg)

Pond Starter Bacteria

- Quickly establishes biological ecosystem
- Great for spring startups and new ponds
- Safe for fish, plants, and animals



Pond Starter Bacteria				
Item Number	96013	96014	96015	96008
Package Size	8 oz. / 236 ml	16 oz. / 473 ml	32 oz. / 946 ml	1 gal. / 3.78 L
1 Pump Treats	100 gal. / 378 L			600 gal. / 2,268 L
1 Bottle Treats	5,000 gal. / 18,900 L	10,000 gal. / 37,800 L	20,000 gal. / 75,600 L	80,000 gal. / 302,400 L
Packaged Weight	.75 lb. (340 g)	1.25 lb. (.56 kg)	2.5 lb. (1.1 kg)	8 lb. (3.6 kg)

Bacteria Bubble Tabs

- Keeps pond water clean and clear
- Maintains a balanced ecosystem
- Reduces pond maintenance



Bacteria Bubble Tabs		
Item Number	98951	98930
Package Size	36 Tabs	72 Tabs
1 Tablet Treats	100 gal. / 378 L	
1 Container Treats	3,600 gal. / 13,608 L	7,200 gal. / 27,216 L
Packaged Weight	.25 lb. (.11 kg)	.75 lb. (.34 g)

Pond Sludge Remover Packs

- Eliminates and prevents pond sludge
- Water soluble packs make it easy to spot treat and treat hard-to-reach areas
- Keeps rocks, gravel, and filters clean



Pond Sludge Remover Packs

Item Number	96081	96084	96082
Package Size	18 Packs	36 Packs	72 Packs
1 Pack Treats	1,000 gal. / 3,780 L		
1 Container Treats	18,000 gal. / 68,040 L	36,000 gal. / 120,960 L	72,000 gal. / 272,550 L
Packaged Weight	.5 lb. (.23 kg)	1 lb. (.45 kg)	2.5 lb. (1.1 kg)

Sludge & Filter Cleaner

- Biological pond and filter cleaner
- Contains five strains of heterotrophic bacteria
- Contains marigold and humic acid
- Safe for fish, plants, and animals



Sludge & Filter Cleaner

Item Number	98889	98890	98891	98883
Package Size	8 oz. / 236 ml	16 oz. / 473 ml	32 oz. / 946 ml	1 gal. / 3.78 L
1 Pump Treats	100 gal. / 378 L			600 gal. / 2,268 L
1 Bottle Treats	5,000 gal. / 18,900 L	10,000 gal. / 37,800 L	20,000 gal. / 75,600 L	80,000 gal. / 302,400 L
Packaged Weight	.75 lb. (340 g)	1.25 lb. (.56 kg)	2.5 lb. (1.1 kg)	8 lb. (3.6 kg)

Pond Detoxifier

- Makes tap water safe for fish and plants
- Removes and detoxifies chlorine
- Neutralizes ammonia
- Detoxifies and chelates copper and heavy metal



Pond Detoxifier			
Item Number	98876	98877	96010
Package Size	8 oz. / 236 ml	16 oz. / 473 ml	1 gal. / 3.78 L
1 Pump Treats	100 gal. / 378 L		600 gal. / 2,268 L
1 Bottle Treats	5,000 gal. / 18,900 L	10,000 gal. / 37,800 L	80,000 gal. / 302,400 L
Packaged Weight	.75 lb. (.340 g)	1.25 lb. (.56 kg)	8 lb. (3.6 kg)

Ammonia Neutralizer

- Neutralizes large concentrations of toxic ammonia
- Makes pond water safe for fish and plants
- Detoxifies chloramine in tap water



Ammonia Neutralizer			
Item Number	96050	96051	96052
Package Size	16 oz. / 473 ml	32 oz. / 946 ml Pouch	1 gal. / 3.78 L
1 Pump Treats	100 gal. / 378 L		600 gal. / 2,268 L
1 Bottle Treats	10,000 gal. / 37,800 L	20,000 gal. / 75,600 L	80,000 gal. / 302,400 L
Packaged Weight	1.25 lb. (.56 kg)	2.25 lb. (1 kg)	8 lb. (3.6 kg)



#96027 #96028 Alkalinity Booster

- Keeps pond water clean and clear
- Maintains a balanced ecosystem
- Reduces pond maintenance

#80000 Activated Pond Carbon

- Removes discoloration and odors
- Made with bamboo carbon
- Clarifies pond water

#98909 Pond Foam Free

- Safely eliminates foam near waterfalls
- Helps keep water clean and clear of foam
- Safe for fish, animals, and plants

	Alkalinity Booster		Activated Pond Carbon	Pond Foam Free
Item Number	96027	96028	80000	98909
Package Size	1.1 lb. / 500 g	9 lb. / 4.08 kg	2.25 lb. / 1 kg	8 oz. / 236 ml
1 Scoop/Pump Treats	125 gal. / 472 L		25 gal. / 95 L	100 gal. / 378 L
1 Container/Bottle Treats	5,000 gal. / 18,900 L	40,750 gal. / 154,035 L	800 gal. / 3,024 L	5,000 gal. / 18,900 L
Packaged Weight	3 lb. (1.4 kg)	9.75 lb. (4.4 kg)	2.25 lb. (1 kg)	.75 lb. (.340 g)

Algaecide

- No more algae growth
- Controls string algae
- Clears green water
- Can be used in ponds with fish and plants

 Only Available for Sale in the USA



Algaecide					
Item Number	96022	96023	96024	96026	96053
Package Size	8 oz. / 236 ml	16 oz. / 473 ml	32 oz. / 946 ml	1 gal. / 3.78 L	2.5 gal. / 9.46 L
1 Tsp. Treats	50 gal. / 189 L				
1 Bottle Treats	2,500 gal. / 9,450 L	5,000 gal. / 18,900 L	10,000 gal. / 37,800 L	40,000 gal. / 151,400 L	100,000 gal. / 378,541 L
Packaged Weight	.75 lb. (340 g)	1.25 lb. (.56 kg)	2.5 lb. (1.1 kg)	8.5 lb. (3.8 kg)	21 lb. (9.5 kg)

EcoBlast® Contact Granular Algaecide

- Eliminates algae from water features on contact
- Can be used at any water temperature
- For use in water features containing live fish and plants

 Only Available for Sale in the USA



EcoBlast® Contact Granular Algaecide			
Item Number	29311	29312	29313
Package Size	8.8 oz. / 250 g	38.4 oz. / 1.1 kg	7 lb. / 3.2 kg
1 Container Treats	200 sq. ft.	780 sq. ft.	2,275 sq. ft.
Packaged Weight	1 lb. (.45 kg)	3 lb. (1.4 kg)	7 lb. (3 kg)

Say Goodbye to String Algae!



Before

After

For more information, [see page 19](#)

 Only Available for Sale in Canada

Pond & Debris Clarifier

- Quickly cleans unsightly debris
- Scientifically blended to quickly restore the water quality
- Reduces pond maintenance



Pond & Debris Clarifier				
Item Number	96002	96003	96005	96006
Package Size	8 oz. / 236 ml	16 oz. / 473 ml	32 oz. / 946 ml	1 gal. / 3.78 L
1 Tsp. Treats	50 gal. / 189 L			
1 Bottle Treats	2,500 gal. / 9,450 L	5,000 gal. / 18,900 L	10,000 gal. / 37,800 L	100,000 gal. / 378,541 L
Packaged Weight	.75 lb.	1.25 lb.	2.5 lb.	8 lb.

SAB Stream & Pond Cleaner

- Breaks down debris
- Maintains a balanced ecosystem
- Reduces pond maintenance
- Phosphate binder



SAB Stream & Pond Cleaner				
Item Number	98898	98899	98900	98896
Package Size	4.4 oz. / 125 g	8.8 oz. / 250 g	1.1 lb. / 500 g	7 lb. / 3.2 kg
1 Scoop Treats	120 gal. / 454 L			1,420 gal. / 5,368 L
1 Container Treats	1,200 gal. / 4,536 L	2,400 gal. / 9,072 L	4,900 gal. / 18,597 L	31,240 gal. / 118,256 L
Packaged Weight	.25 lb. (.11 kg)	.75 lb. (340 g)	1.25 lb. (.56 kg)	7.5 lb. (3.4 kg)

Barley Straw Extract

- Promotes clean, clear water conditions in ponds and streams
- Starts working instantly
- Concentrated formulation with added enzymes



Barley Straw Extract				
Item Number	98903	98904	98905	96012
Package Size	8 oz. / 326 ml	16 oz. / 473 ml	32 oz. / 946 ml	1 gal. / 3.78 L
1 Pump Treats	100 gal. / 378 L			600 gal. / 2,268 L
1 Bottle Treats	5,000 gal. / 18,900 L	10,000 gal. / 37,800 L	20,000 gal. / 75,600 L	80,000 gal. / 302,400 L
Packaged Weight	.75 lb. (340 g)	1.25 lb. (.56 kg)	2.5 lb. (1.1 kg)	8 lb. (3.6 kg)

Rapid Clear Flocculant

- Quickly clears cloudy water by clumping debris
- Works within 24 hours
- For best results, use in combination with a Rapid Clear Fine Filter Pad (#80001)



Item Number	98879	96049	96007	80001
Package Size	8 oz. / 236 ml	16 oz. / 473 ml	1 gal. / 3.78 L	12"W x 24"L
1 Pump Treats	100 gal. / 378 L		600 gal. / 2,268 L	—
1 Bottle Treats	5,000 gal. / 18,900 L	10,000 gal. / 37,800 L	80,000 gal. / 302,400 L	—
1 Package Treats	—	—	—	3 Pads Included
Packaged Weight	.75 lb. (340 g)	1.25 lb. (.56 kg)	85 lb. (38.5 kg)	.75 lb. (340 g)



QuickFix Pond Gummy

- 320 billion viable bacteria cultures specifically selected for their ability to quickly resolve a variety of pond problems
- Free enzymes which trigger digestion to help break down organics
- 1 Package Treats 3,000 gal/ 11,340 L above the package weight

Packaged Weight .25 lb. (.11 kg)

#96083



Concentrated Barley Straw Pellets

- Fast-acting, natural way to clarify pond water
- Comes in a resealable mesh bag
- Contains a blend of bacteria and enzymes

#96029



Black Pond Dye

- Filters sunlight and cools water
- Contains humic acid and enzymes to help balance the pond ecosystem
- Creates a shimmering effect
- One dosage lasts up to 6 weeks

#98884



Blue Pond Dye

- Safely tints pond water
- Added enzymes help balance the pond ecosystem
- One dosage lasts up to 6 weeks

#98882

	Concentrated Barley Straw Pellets	Black Pond Dye	Blue Pond Dye
Item Number	96029	98884	98882
Package Size	5 lb. / 2.3 kg	8 oz. / 236 ml	
1 Pump Treats	—	100 gal. / 378 L	
1 Container Treats	1,000 gal. / 3,780 L	5,000 gal. / 1,890 L	
Packaged Weight	5.5 lb. (2.5 kg)	.75 lb. (340 g)	

AquaGarden Maintenance 4-in-1

For use with the AquaGarden Mini Pond Kits (#78325, #78333) and AquaGarden Tabletop Fountain Kits (#78346, #78347)

- A powerful blend of beneficial bacteria and clarifiers, with scale and foam removers, keeps water clean, clear, healthy, and maintenance free
- Allows for precise dosing in smaller container water gardens



AquaGarden Maintenance 4-in-1		
Item Number	96097	96098
For use with	AquaGarden Tabletop Fountain Kit	AquaGarden Mini Pond Kit
Package Size	2 fl. oz. / 59 ml	4 fl. oz. / 177 ml
Treatment Rate	Add 1 to 2 droppers every week	Add 5 droppers (2 tsp.) every week
1 Bottle Lasts	7 to 12 months	Up to 3 months
Packaged Weight	4.4 oz. / 130 ml	8.4 oz. / 248 ml



	Patio Pond Maintenance Tabs	Fountain Foam Free	Rock & Fountain Cleaner	Fountain Maintenance		Fountain Scale Free
Item Number	40004	98908	96055	40007	96056	98907
Package Size	36 Tabs	8 oz. / 236 ml	32 oz. / 946 ml	8 oz. / 236 ml	16 oz. / 473 ml	8 oz. / 236 ml
Purpose	Helps optimize water quality	Helps keep water clear of foam	Cleans debris that attaches to rocks and fountains	Prevents scale and debris build up		Helps prevent hard water deposits
1 Tablet Treats	100 gal. 378 L	—				
1 Container Treats	3,600 gal. / 13,608 L	—				
1 Pump Treats	—	10 gal. / 37.8 L	—	10 gal. / 37.8 L		
1 Bottle Treats	—	500 gal. / 1,890 L	up to 300 sq. ft.	500 gal. / 1,890 L	1,000 gal. / 3,785 L	500 gal. / 1,890 L
Packaged Weight	.25 lb. (.11 kg)	.75 lb. (340 g)	2.5 lb. (1.1 kg)	.75 lb. (340 g)	1.25 lb. (.56 kg)	.75 lb. (340 g)



Beneficial Bacteria Professional Grade

- Provides clean, clear, and healthy water conditions
- Contains photosynthetic bacteria
- Contains marigold and vitamin B

#30406



Beneficial Bacteria Concentrate Professional Grade

- Provides clean, clear, and healthy water conditions
- Contains eight strains of bacteria
- Contains photosynthetic bacteria

#30407



Cold Water Beneficial Bacteria Professional Grade

- Provides clean, clear, and healthy water conditions
- Reduces ammonia, nitrite, and organic debris
- Ideal for use in water colder than 50°F (5°C)

#98895



Pond Starter Bacteria Professional Grade

- Establishes biological ecosystem
- Great for spring start-up and new ponds

#40011



Wetland Pond & Lake Bacteria Professional Grade

- Naturally reduces ammonia, nitrate, and excess nutrients
- Includes eight pure strains of beneficial bacteria, including photosynthetic bacteria
- Maintains a balanced ecosystem

#98897



Rapid Clear Flocculant Professional Grade

- Clears discolored or cloudy water
- Clumps suspended debris (flocculation)
- Clears most ponds in 24 hours

#30412

Item Number	30406	30407	98895	40011	98897	30412
Option	●	●	●	●	●	●
Package Size	1 gal / 3.78 L	9 lb / 4.08 kg	1 gal / 3.78 L			
1 Scoop Treats	6,000 gal. 22,680 L	48,000 gal. 181,440 L	6,000 gal. / 22,680 L		48,000 gal. 181,440 L	6,000 gal. 22,712 L
1 Container Treats	96,000 gal. 362,880 L	870,000 gal. 3,293,308 L	96,000 gal. / 362,880 L		768,000 gal. 2,903,040 L	96,000 gal. 363,400 L
Packaged Weight	9 lb. (4 kg)	9.5 lb. (4.3 kg)	9 lb. (4 kg)			

● Beneficial Bacteria ● Problem Solving



Pond & Debris Clarifier Professional Grade

- Quickly cleans unsightly debris
- Restores water quality
- Reduces pond maintenance

#40010



SAB Stream & Pond Cleaner Professional Grade

- Keeps pond water clean and crystal clear
- Reduces pond maintenance
- Reduces ammonia and nitrates
- Phosphate binder

#30409



Waterfall & Rock Cleaner Professional Grade

- Spot treats the trouble areas on water features
- Quickly eliminates debris from waterfalls and rocks
- Reduces pond maintenance
- Goes to work instantly

#30413



Barley Straw Extract Professional Grade

- Natural way to clarify water
- Provides clear, clean pond conditions
- Starts working instantly
- Concentrated formulation with added enzymes

#98906



Ammonia Neutralizer Professional Grade

- Makes pond water safe for fish and plants
- Detoxifies chloramine in tap water
- Instantly neutralizes large concentrations of toxic ammonia

#40012



Pond Detoxifier Professional Grade

- Makes tap water safe for fish and plants
- Removes and detoxifies chlorine and chloramines
- Neutralizes ammonia
- Detoxifies and chelates copper and heavy metals

#30410



Sludge & Filter Cleaner Professional Grade

- Biological pond and filter cleaner
- Contains five strains of heterotrophic bacteria
- Contains marigold and humic acid

#30408

Item Number	40010	30409	30413	98906	40012	30410	30408
Option		●			●		●
Package Size	1 gal / 3.78 L	9 lb / 4.08 kg			1 gal / 3.78 L		
1 Scoop Treats	6,000 gal. 22,712 L	3,000 gal. 11,340 L	151-200 sq. ft.		6,000 gal. / 22,680 L		
1 Container Treats	96,000 gal. 363,400 L	45,000 gal. 170,000 L	3,650 sq. ft.		96,000 gal. / 362,880 L		
Packaged Weight		9.5 lb. (4.3 kg)		9.75 lb. (4.4 kg)	9 lb. (4 kg)	9.5 lb. (4.3 kg)	9.25 lb. (4.2 kg)

- Problem Solving
- Water Conditioners
- Sludge Fighting

Aquascape lake treatments are optimized specifically for larger bodies of water and can cause issues when used in smaller water features.



Lake Bacteria Packs

- Restores the ecosystem, keeping water clean, clear, and healthy
- Easy-to-use water soluble packs make it easy to treat hard-to-reach areas
- Significantly reduces maintenance
- Fortified with prebiotics to enhance water quality



Lake Bacteria

- Restores the ecosystem, keeping water clean, clear, and healthy
- Significantly reduces maintenance
- Fortified with prebiotics to enhance water quality

	Lake Bacteria Packs			Lake Bacteria
Item Number	40013	40014	40015	40016
Package Size	24 Packs	48 Packs	192 Packs	1 gal / 3.78 L
4 Packs Treat	1/4 acre for 1 month			—
1 Container Treats	Up to 1.5 acres	Up to 3 acres	Up to 12 acres	1/4 acre for 1-3 months
Packaged Weight	3 lb. (1.36 kg)	7 lb. (3.2 kg)	25 lb. (11.3 kg)	9.25 lb. (4 kg)



Lake Sludge Remover Packs

- Quickly eliminates organic sludge and muck
- Easy-to-use water soluble packs make it easy to spot treat and treat hard-to-reach areas
- All active ingredients with no fillers or binders
- Slowly releases oxygen to maximize sludge reduction
- Added macrobiotics and carbon source

	Lake Sludge Remover Packs		
Item Number	40017	40018	40019
Package Size	192 Packs	384 Packs	1,152 Packs
1 Pack Treats	250 ft ²		
1 Container Treats	48,000 ft ²	96,000 ft ²	288,000 ft ²
Packaged Weight	4.2 lb. (1.9 kg)	9.5 lb. (4.3 kg)	29 lb. (13 kg)



Lake Blue Dye Packs

- Shades water to prevent water quality issues
- Easy-to-use water soluble packs
- Significantly reduces maintenance, filters sunlight, and cools water temperature



Lake Flocculant Clarifier

- Quickly clears cloudy water caused by suspended particles
- Optimized to clarify clay, mineral material, and sediment issues
- Significantly reduces maintenance

	Lake Blue Dye Packs			Lake Flocculant Clarifier
Item Number	40020	40021	40022	40023
Package Size	2 Packs	4 Packs	16 Packs	1 gal. / 3.78 L
1 Pack Treats	1.5 acre ft.			—
1 Container Treats	Up to 3 acre ft.	Up to 6 acre ft.	Up to 24 acre ft.	1/4 acres for 1-3 months
Packaged Weight	.5 lb. (227 g)	1 lb. (.45 kg)	4 lb. (1.81 kg)	9.25 lb. (4 kg)



Lake Phosphate Binder Packs

- Quickly binds phosphates to clean and clear water
- Easy-to-use water soluble packs
- Prevents and eliminates floating debris and debris that attaches to rocks and gravel
- Significantly reduces maintenance
- Binds orthophosphate



Lake Treatment Booster Packs

- Turbo boost the effects of all lake treatments
- Easy-to-use water soluble packs
- Adds oxygen directly to the water to accelerate nutrient uptake and sludge digestion
- Increases bacterial growth by up to ten times
- Great for non-aerated or highly eutrophic bodies of water

	Lake Phosphate Binder Packs			Lake Treatment Booster Packs		
Item Number	40024	40025	40026	40027	40028	40029
Package Size	192 Packs	384 Packs	1,152 Packs	192 Packs	384 Packs	1,152 Packs
1 Pack Treats	250 ft ²					
1 Container Treats	48,000 ft ²	96,000 ft ²	288,000 ft ²	48,000 ft ²	96,000 ft ²	288,000 ft ²
Packaged Weight	5 lb. (2.3 kg)	9.25 lb. (4 kg)	29 lb. (13kg)	4.75 lb. (2 kg)	9.5 lb. (4.3 kg)	28.5 lb. (13 kg)

Seasonal Care



SPRING

To keep your pond looking its best all season long, you want to start it off right in the springtime. See our list of favorite must-have spring products.

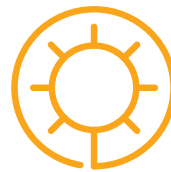

SUMMER

Summer is most likely the season when you will spend the majority of time with your pond; fortunately, summer maintenance is minimal.



AUTUMN

Fall brings the changing of leaves, and eventually the falling of leaves. Excess debris like fallen leaves and sticks can lead to issues with water clarity and quality.



WINTER

If you have fish in your pond and it freezes over in the winter, it is important to maintain an opening in the ice all winter to allow for proper gas exchange. One way to do this is by using the Aquascape Pond De-Icer and Pond Aerator system.

Aquascape ecosystem ponds are naturally balanced and require very little care. You can easily maintain the health of your pond throughout the year with our comprehensive line of seasonal products.

K | F | P | A | L | P A | W T | S C | F P C | D | L U G | P P | I T



Temperature Indicator

Numeric temperature indicator displays current temperature in F or C (-20°F and 120°F / -28°C and 48°C)

WiFi Pairing

Allows for quick and easy connection to your smart phone or tablet

Integrated Display Panel

For use without smartphone or tablet

Smart Pond Thermometer Shown

Weighted Base

Allows for quick and discreet placement

	Smart Pond Thermometer	Smart Pond Thermometer with Transformer
Item Number	74012	74013
Wattage	1	
12V Transformer	Required (Sold Separately)	✓
Probe Size	1.75" Dia.	
Power Cord Length	3'	
Probe Cord Length	20'	
Warranty	3-Year Limited	
Packaged Weight	1 lb. (453 g)	1.5 lb. (.68 kg)
Packaged Dimensions	5.5"L x 2.55"W x 5.7"H	



Submersible Pond Thermometer

Packaged Weight: .25 lb. (.11 kg)

Packaged Dimensions: 5"L x 9"W x 1"H

#74000

Built-In LED Light

Indicates when the unit is operating



Internal Thermostat

Acts as a safety feature and signals built-in LED light

Stainless Steel Construction

Prevents corrosion and cracking

300-Watt Pond De-Icer

Packaged Weight: 4.5 lb. (2 kg)

Dimensions: 5.5" Dia. x 4"H with 22' Cord

Packaged Dimensions: 9"L x 9"W x 7"H

#39000



Bulk Protective Pond Netting
20' x 100' Shown



Perforated hole
for easy dispensing

Protective Pond Netting

	7' x 10'	14' x 20'	28' x 30'	Bulk 10' x 100'	Bulk 20' x 100'	Bulk 30' x 100'
Item Number	98000	98001	98002	74007	74002	74003
Packaged Weight	.75 lb. (340 g)	1.1 lb. (.49 kg)	2.5 lb. (1.1 kg)	8 lb. (3.6 kg)	14.5 lb. (6.6 kg)	20.5 lb. (9.3 kg)
Packaged Dimensions	5.5"L x 3"W x 9"H	7.25"L x 4.75"W x 15"H	10.5"L x 50"W x 5"H	20"L x 18"W x 10"H	20"L x 18"W x 13"H	21"L x 23"W x 18"H



U-Shaped Ground Stakes - 100 pieces

Ideal for securing or anchoring netting over ponds and waterfalls. The durable and sturdy landscape staples are three-inches long with 11-gauge thickness, making them perfect for use around the perimeter of water features.

Packaged Weight: 1.75 lb. (.79 kg)

Packaged Dimensions: 7"L x 1.5"W x 8"H

#74008

Fish Care, Plant Care, and Predator Control



Fish Care



Plant Care



Predator Control



We've combined categories!

Now you can find everything you need for your fish care, plant care, and predator control needs.

K | F | P | A | L | P | A | W | T | S | C | F | P | C | D | L | U | G | P | P | I | T



Premium Staple Fish Food Pellets

Item Number	98867	98868	98869	81049	50003	81050	81051	81052	81053
Weight	1.1 lb. 500 g	2.2 lb. 1 kg	4.4 lb. 2 kg	11 lb. 5 kg	44 lb. 20 kg	1.1 lb. 500 g	2.2 lb. 1 kg	4.4 lb. 2 kg	11 lb. 5 kg
Pellet Size	Small (2-4 mm)		Large (6-8 mm)			Mixed (2-8 mm)			
Feeding Temperature	Minimum water temperature of 60°F/15°C								
Recommendation	Ideal for fish from 3" (8 cm) and above		Ideal for fish from 8" (20 cm) and above			Ideal for all size fish			



Premium Color Enhancing Fish Food Pellets

Item Number	98873	98874	98875	81048	81006
Weight	1.1 lb. / 500 g	2.2 lb. / 1 kg	4.4 lb. / 2 kg	11 lb. / 5 kg	44 lb. / 20 kg
Pellet Size	Small (2-4 mm)		Large (6-8 mm)		
Feeding Temperature	Minimum water temperature of 60°F/15°C				
Recommendation	Ideal for fish from 3" (8 cm) and above		Ideal for large fish from 8" (20 cm) and above		



Premium Cold Water Fish Food Pellets

Item Number	98870	98871	98872	81047	81004
Weight	1.1 lb. / 500 g	2.2 lb. / 1 kg	4.4 lb. / 2 kg	11 lb. / 5 kg	44 lb. / 20 kg
Pellet Size	Small (2-4 mm)		Large (6-8 mm)		
Feeding Temperature	Minimum water temperature of 50°F/10°C				
Recommendation	Ideal for fish from 3" (8 cm) and above		Ideal for large fish from 8" (20 cm) and above		

**Premium Fish Food Flakes 4.2 oz. / 119 g****Color-Enhancing**

Formulated to enhance and brighten colors in all pond fish

Probiotics

Easy to digest and reduces fish waste

Packaged Weight: .5 lb.

Packaged Dimensions: 3.5"L x 3.5"W x 7.5"H

#98878

**Koi Krunchies 14.1 oz. / 400 g****Ideal For Hand Feeding**

The size, shape, and taste of the Koi Krunchies make them a perfect tool for training your fish to hand feed

Nutritious Treat

Contains high-quality ingredients and natural citrus flavors

Great Source of Vitamin C

Aquascape Koi Krunchies aid in proper tissue formation, digestion, and disease resistance

Packaged Weight: 1.25 lb.



Packaged Dimensions: 6"L x 6"W x 10"H

#81000



Aquascape offers a basic line of fish treatments that target most issues experienced by pond fish. Check the chart on pg 85 to identify the problem, and treat with the corresponding product.



	Praziquantel Treatment 8 oz. / 236 ml	Fungus Treatment 8 oz. / 236 ml	Parasite & Ich Treatment 8 oz. / 236 ml	Ulcer & Bacterial Treatment 8.8 oz. / 250 g	Pond Salt 2 lb. / 0.9 kg 9 lb. / 4.08 kg 40 lb. / 18.16 kg
Item Number	81041	81040	81039	81038	99416 99417 40003
Packaged Weight		.5 lb.	.75 lb.	.5 lb.	2.25 lb. 10 lb. 41.5 lb.
5 ml Treats		25 gal. / 94 L			—
1 Scoop Treats		—		125 gal. / 472 L	190 gal. / 718 L
1 Container Treats		1,250 gal. / 4,725 L		4,875 gal. / 18,472 L	Up to 1,520 gal. / 5,745 L Up to 6,840 gal. / 25,835 L Up to 30,400 gal. / 114,912 L
Available In	 Only Available for Sale in the USA				  Available for Sale in the USA & Canada



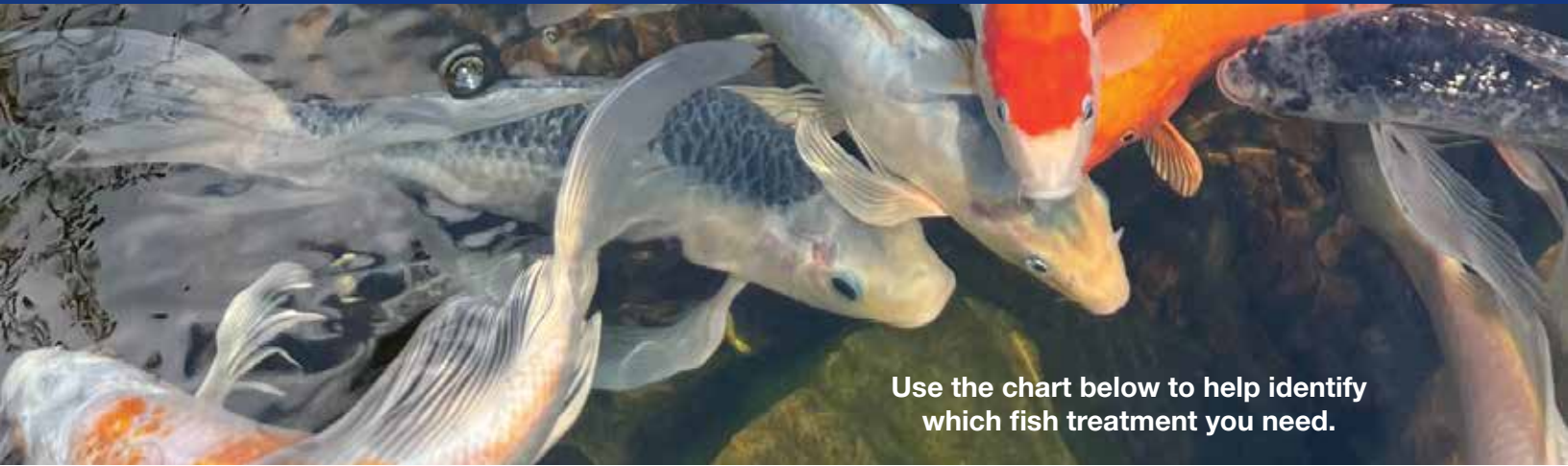

Use the chart below to help identify which fish treatment you need.

Symptoms and Possible Treatments

Fish Symptom	Possible Problems	Treatment
Erratic movement, flashing or rubbing on rocks and surfaces throughout the pond	<ul style="list-style-type: none"> Parasite Problem 	<ul style="list-style-type: none"> Aquascape Parasite & Ich Treatment Aquascape Praziquantel Treatment Aquascape Pond Salt
Growths that look like "cotton balls"	<ul style="list-style-type: none"> Fungal Infection 	<ul style="list-style-type: none"> Aquascape Fungus Treatment
Open wounds or ulcers	<ul style="list-style-type: none"> Bacterial Infection 	<ul style="list-style-type: none"> Aquascape Ulcer & Bacterial Infection Treatment
Fins appear to be rotting away	<ul style="list-style-type: none"> Fin Rot Bacterial Infection 	<ul style="list-style-type: none"> Aquascape Ulcer & Bacterial Infection Treatment Aquascape Pond Salt
Red streaks in the fins	<ul style="list-style-type: none"> Bacterial Infection Parasite Problem Ammonia Poisoning 	<ul style="list-style-type: none"> Aquascape Parasite & Ich Treatment Aquascape Praziquantel Treatment Aquascape Pond Salt and water change using Aquascape Pond Detoxifier Aquascape Ammonia Neutralizer
Small, white spots that look like salt stuck to the body of the fish	<ul style="list-style-type: none"> Ich Parasite Problem 	<ul style="list-style-type: none"> Aquascape Parasite & Ich Treatment Aquascape Pond Salt
Gasping at the surface of the water	<ul style="list-style-type: none"> Oxygen Depletion 	<ul style="list-style-type: none"> Aerate the pond and agitate the pond surface Reduce fish load
Bulging eyes	<ul style="list-style-type: none"> Bacterial Infection 	<ul style="list-style-type: none"> Aquascape Ulcer & Bacterial Infection Treatment
Scales protruding from a swollen body like a pine cone	<ul style="list-style-type: none"> Dropsy Bacterial Infection 	<ul style="list-style-type: none"> Difficult to treat; treat the pond as a preventative measure Aquascape Ulcer & Bacterial Infection Treatment
Difficulty swimming underwater floating at the surface upright	<ul style="list-style-type: none"> Swim Bladder Disease 	<ul style="list-style-type: none"> If the fish is still feeding, feed fish with canned peas or a Spirulina-based fish food
Red or swollen gills	<ul style="list-style-type: none"> Parasite Problem 	<ul style="list-style-type: none"> Aquascape Parasite & Ich Treatment Aquascape Praziquantel Treatment Aquascape Pond Salt



	Pond Skimmer Net with Extendable Handle	Heavy Duty Pond Skimmer Net with Extendable Handle	Professional-Grade Pond Skimmer Net	Pond Shark	Pond Shark Pro
Item Number	98559	98562	50001	74004	74005
Handle Length	32", extends to 63"	36", extends to 63"	40"	Extends up to 60"	Extends up to 96"
Packaged Weight	.75 lb.	1.4 lb.	2 lb.	2.1 lb.	
Dimensions	12"L x 7"W	15"L x 15"W	23"L x 20.5"W Net	12"L x 8"W x 12"D	
Recommended Usage	Remove fine debris				



	Koi Sock Net	Kid's Pond Explorer Net	Professional-Grade Pond Net	Pond Net with Extendable Handle	Heavy Duty Pond Net with Extendable Handle	Professional Fish Net with Extendable Handle
Item Number	81057	98556	50000	98558	98560	98561
Handle Length	8"	12"	40"	32", extends up to 63"	36", extends up to 69"	32", extends up to 69"
Packaged Weight	1.2 lb.	.2 lb.	2 lb.	.75 lb.	1.4 lb.	2.1 lb.
Dimensions	24"L x 13"W x 38.5"D	10"L x 7"W	23"L x 20.5"W Net	12"L x 7"W	15"L x 15"W	22" Dia. head
Recommended Usage	Catch/transport fish	Catch small fish or removing debris	Catch fish and removing large debris			Catch fish



	Faux Rock Fish Cave - Small	Faux Rock Fish Cave - Large	Faux Log Fish Cave
Item Number	78418	78419	78324
Dimensions	25"L x 15"W x 9.5"H	30"L x 18"W x 11"H	19"L x 12"W x 10"H
Primary Material	Fiber-Resin Composite	Fiber-Resin Composite	Polyresin
Packaged Weight	10.5 lb. (4.7 kg)	14 lb. (6.3 kg)	7.8 lb. (3.5 kg)
Packaged Dimensions	25.25"L x 18.25"W x 12.25"H	32"L x 20.5"W x 15"H	22"L x 15"W x 13"H



	Blue Heron Decoy	Floating Alligator Decoy	Floating Swan Decoy
Item Number	81030	93000	74014
Dimensions	9"L x 6"W x 26"H	34"L x 6"W x 4"H	31"L x 15"W x 18"H
Primary Material	Polyresin		
Packaged Weight	2.25 lb. (1 kg)	2.5 lb. (1 kg)	5 lb. (2.3 kg)
Packaged Dimensions	28"L x 9"W x 6.25"H	11.5"L x 7.5"W x 10"H	31.25"L x 14.75"W x 9.25"H

All-Natural

Non-toxic alluvial planting media



NEW



Fine-Grained Media

Perfect for planting or re-potting waterlilies, marginals, and other aquatic plants

Peat Moss and Compost Free

Supports growth of aquatic plants and safe for pond fish

Pond Plant Potting Media

Item Number	89002	89003	89016
Covers	215 cubic inches / 0.0035 cubic meters	432 cubic inches / 0.007 cubic meters	864 cubic inches / .014 cubit meters

"Perfect for supporting the growth of pond plants"



Great for fertilizing without re-potting



Great for re-potting or for new plants



Once-A-Year Pond Plant Fertilizer

- Formulated specifically for pond plants
- Once-a-year, time-released formula provides impressive growth throughout the entire season
- Available in granular or capsule form

INNOVATIVE FERTILIZER FOR POND PLANTS!

NPK Blend (11-3-14)

- No excess nitrogen
- Lower phosphorous
- Higher potassium for flowering

180 Day Formula

- Feeds all season long
- No leftover in the spring



Only Available for Sale in the USA



	6-Pack Capsules	12-Pack Capsules	2 lb. Granular	7 lb. Granular
Item Number	89010	89011	89013	89014
Package Dimensions	5"L x 8"H x 2.5"W	6"L x 9"H x 3"W	6"L x 9"H x 3"W	9"L x 13.5"H x 4.75"W
Packaged Weight	.75 lb. (340 g)	1.3 lb. (589 g)	2 lb. (907 g)	7 lb. (3.2 kg)

Note: Refer to the website or product label for how much fertilizer to use for your plants.

Heavy-Duty Aquatic Plant Pots

Provide a more heavy-duty, professional alternative to our standard Aquatic Planters.



Heavy-Duty Nylon Straps

Make it easy to lift and maneuver in and out of the pond

Specialized Geotextile Fabric

Allows for proper root development due to increased access to oxygen and nutrients, resulting in more robust and faster growing plants

Heavy-Duty Aquatic Plant Pots

Item Number	47003	47004	47005
Planter Dimensions	12" Dia. x 6" H (30.5 cm Dia. x 15.2 cm H)	16" Dia. x 7" H (40.6 cm Dia. x 17.8 cm H)	20" Dia. x 8" H (50.8 cm Dia. x 20.3 cm H)
Potting Media Capacity	432 cubic inches / 0.0071 cubic meters	864 cubic inches / 0.0142 cubic meters	1,512 cubic inches / 0.0248 cubic meters



	Aquatic Planter 6" x 6" (2-pack)	Aquatic Planter 8" x 6" (2-pack)	Aquatic Planter 12" x 8" (2-pack)	Aquatic Lily Planter-14" x 7" (2-pack)	Floating Plant Island
Item Number	98501	98502	98500	98929	89006
Packaged Weight	.25 lb. (113 g)			.5 lb. (227 g)	
Dimensions	6" Dia. x 6"H	8" Dia. x 6"H	12" Dia. x 8"H	14" Dia. x 7"H	15"L x 11"W x 4"H
Packaged Dimensions	6.5"L x 7"W x 1"H	11.5"L x 8"W x 1"H	12"L x 8"W x 5"H	12"L x 9.5"W x 1"H	16"L x 4"W x 12.5"H



Decorative Water Features



Fountain Bowls



AquaGarden



Accessories



Decorative water features are the easiest and quickest way to start Living the Aquascape Lifestyle®. Our fountains and spitters can be stand-alone features or installed into an existing pond to add a unique decorative accent to your water garden. Our decorative features make it easy to add the relaxing sights and sounds of water to any location.

K | F | P | A | L | P A | W T | S C | F P C | D | L U G | P P | I T

Fountain Bowls







Use as a patio pond



Install as spilling bowl



Create a biological filter

Round Fountain Bowls			
Item Number	Color	Dimensions	Holds up to Gal/Liter
78391	 Merlot	32" Dia x 14" H (81 Dia x 36 H cm)	29/109
78392		40" Dia x 16" H (102 Dia x 41 H cm)	69/261
78393		50" Dia x 20" H (127 Dia x 51 H cm)	109/412
78394		60" Dia x 22" H (152 Dia x 56 H cm)	180/681
78395	 Lunar Gray	32" Dia x 14" H (81 Dia x 36 H cm)	29/109
78396		40" Dia x 16" H (102 Dia x 41 H cm)	69/261
78397		50" Dia x 20" H (127 Dia x 51 H cm)	109/412
78398		60" Dia x 22" H (152 Dia x 56 H cm)	180/681
78399	 Green Slate	32" Dia x 14" H (81 Dia x 36 H cm)	29/109
78400		40" Dia x 16" H (102 Dia x 41 H cm)	69/261
78401		50" Dia x 20" H (127 Dia x 51 H cm)	109/412
78402		60" Dia x 22" H (152 Dia x 56 H cm)	180/681
78403	 Gray Slate	27" Sq x 14" H (69 Sq x 36 H cm)	28/106
78404		33" Sq x 16" H (84 Sq x 41 H cm)	49/185



Square Fountain Bowl Shelves

Item Number	Fits Bowl Size
78409	Fits 27" Sq (69 cm)
78411	Fits 33" Sq (84 cm)

Note: Shelves not available for 50" and 60" bowls



Round Fountain Bowl Shelves

Item Number	Fits Bowl Size
78405	Fits 32" Dia (81 cm)
78407	Fits 40" Dia (102 cm)

Note: Shelves not available for 50" and 60" bowls



Fountain Bowl Shelves

Item Number	Description
78413	Fits round bowls
78414	Fits square bowls

Note: Includes fasteners

To create a Fountain Bowl Biological Filter, refer to [page 18](#) for product listing



Item 78247, 8' H Shown

Stacked Slate Urns

	13" H (34 cm)	24" H (61 cm)	33.5" H (85 cm)	45" H (114 cm)	55" H (140 cm)	8' H (2.44 m)
Item Number	58014	78359	98939	78207	98940	78247
Dimensions	10"L x 10"W x 13.5"H	15" Dia. x 24"H	21.25" Dia. x 33.5"H	27" Dia. x 45"H	35.5" Dia. x 55"H	5' Dia. x 8'H
Primary Material	Fiber-Resin Composite					
Included Tubing	Silicone 1/2" x 34"	Silicone 3/4" x 53"	Silicone 3/4" x 53"	Silicone 3/4" x 55"	Silicone 3/4" x 71"	—
Recommended Pump	320 GPH Water Pump #91026	Ultra 550 Water Pump #91006	Ultra 550 Water Pump #91006	Ultra 1100 Water Pump #91008	Ultra 2000 Water Pump #91010	—
Recommended Basin	AquaBasin® 30 #78223 or DecoBasin #60000			AquaBasin® 45 #78224	Custom using AquaBlox	
Packaged Weight	6.5 lb.	19.75 lb.	34.5 lb.	56 lb.	104 lb.	262 lb.



KIT AVAILABLE

Stacked Slate Urn Fountain Kit - 24" H (61 cm)

- Comes with AquaBasin® 30, pump and plumbing

Packaged Weight: 45.5 lb. (20.6 kg)

Packaged Dimensions: 30"L x 30"W x 27"H

#78250

See Pages 13-14 for more kits



KIT AVAILABLE

Stacked Slate Urn Fountain Kit - 33.5" H (85 cm)

- Comes with AquaBasin® 30, pump and plumbing

Packaged Weight: 55 lb. (25 kg)

Packaged Dimensions: 30" L x 30"W x 30"H

#78252

See Pages 13-14 for more kits



KIT AVAILABLE

Stacked Slate Urn Fountain Kit - 45" H (114 cm)

- Comes with AquaBasin® 45, pump and plumbing

Packaged Weight: 180 lb. (81.6 kg)

Packaged Dimensions: 40"L x 48"W x 54"H

#58090

See Pages 13-14 for more kits



Item 78428, 6' Dia. Shown

Stacked Slate Spheres					
	18" Dia. (46 cm)	24" Dia. (61 cm)	32" Dia. (81 cm)	40" Dia. (102 cm)	6' Dia. (1.8 m)
Item Number	78358	78287	78288	78289	78428
Dimensions	18.25" Dia. x 16.25"H (46 cm)	24" Dia. x 22"H (61 cm)	32" Dia. x 30"H (81 cm)	40" Dia. x 37.5"H (101.6 cm)	6' Dia. x 5'H (1.8 m)
Primary Material	Fiber-Resin Composite				
Included Tubing	Silicone 3/4" x 35"	Silicone 3/4" x 35"	Silicone 3/4" x 47"	Silicone 3/4" x 55"	–
Recommended Pump	Ultra 550 Water Pump #91006	Ultra 800 Water Pump #91007	Ultra 1500 Water Pump #91009	Ultra 2000 Water Pump #91010	–
Recommended Basin	AquaBasin® 30 #78223	AquaBasin® 45 #78224		Custom using AquaBlox	
Packaged Weight	18.5 lb.	26 lb.	68 lb.	111 lb.	284 lb.



KIT AVAILABLE

Stacked Slate Sphere Fountain Kit - 18" Dia (46 cm)

- Comes with the AquaBasin® 30, pump, and plumbing

Packaged Weight: 40.5 lb. (18.3 kg)

Packaged Dimensions: 30"L x 30"W x 30"H

[#78249](#)

See Page 13-14 for more kits



KIT AVAILABLE

Stacked Slate Sphere Fountain Kit - 32" Dia (81 cm)

- Comes with the AquaBasin® 45, pump, and plumbing

Packaged Weight: 195 lb. (88.4 kg)

Packaged Dimensions: 40"L x 48"W x 46"H

[#78290](#)

See Page 13-14 for more kits



Fire Fountain Add-On Kit

Prepare to be amazed at the difference fire can make for your fountain. Ideal for use with Stacked Slate Spheres and Stacked Slate Urns.

[#78221](#)

Note: Not compatible with [#78428](#) or [#78247](#)

Stacked Slate Walls

Choose an Aquascape Stacked Slate Wall Base and Topper to easily add a unique, customized fountain to any location.



	Stacked Slate Wall Topper Straight Quad-Spill	Stacked Slate Wall Topper Straight Front-Spill	Stacked Slate Wall Base 13" H (33 cm)	Stacked Slate Wall Base 26" H (66 cm)
Item Number	78280	78281	78279	78278
Dimensions	36"L x 12"W x 6"H		36"L x 12"W x 13"H	36"L x 12"W x 26"H
Primary Material	Fiber-Resin Composite			
Included Tubing	✓		—	
Recommended Pump	—		Ultra 2000 Water Pump #91010	
Recommended Basin	—		AquaBasin 45 #78224 or custom using AquaBlox	
Packaged Weight	18.75 lb.		24 lb.	41 lb.





	Stacked Slate Wall Topper Curved Front-Spill	Stacked Slate Wall Topper Curved Rear-Spill	Stacked Slate Wall Topper Curved Quad-Spill	Stacked Slate Wall Base Curved 13" H (33 cm)	Stacked Slate Wall Base Curved 26" H (66 cm)
Item Number	78284	78285	78286	78283	78282
Dimensions	36"L x 12"W x 6"H			36"L x 12"W x 13"H	36"L x 12"W x 26"H
Primary Material	Fiber-Resin Composite				
Included Tubing	✓			—	
Recommended Pump	—			Ultra 2000 Water Pump #91010	
Recommended Basin	—			AquaBasin 45 #78224 or custom using AquaBlox	
Packaged Weight	19.25 lb.	17.5 lb.	19.25 lb.	22.75 lb.	39 lb.



KIT AVAILABLE

Stacked Slate Wall Fountain Kit 32" H (81 cm)

- Comes with the AquaBasin® 45, pump, and plumbing

Packaged Weight: 157 lb. (71 kg)

Packaged Dimensions: 40"L x 48"W x 54"H

#78269

[See Page 14 for more kits](#)





Scalloped Urns

	32" H (81 cm)	45" H (114 cm)	56" H (142 cm)
Item Number	78238	78239	78240
Dimensions	20" Dia. x 32"H	27" Dia. x 45"H	38" Dia. x 56"H
Primary Material	Fiber-Resin Composite		
Included Tubing	Silicone 3/4" x 53"	Silicone 3/4" x 55"	Silicone 3/4" x 71"
Recommended Pump	Ultra 550 Water Pump #91006	Ultra 1100 Water Pump #91008	Ultra 2000 Water Pump #91010
Recommended Basin	AquaBasin 30 #78223 or DecoBasin #60000	AquaBasin 45 #78224	Custom using AquaBlox
Packaged Weight	26 lb.	50 lb.	93 lb.



KIT AVAILABLE

Scalloped Urn Fountain Kit 45" H (114 cm)

- Comes with AquaBasin® 45, pump, and plumbing

Packaged Weight: 145 lb. (65.7 kg)

Packaged Dimensions:
40"L x 48"W x 52"H

#78270

See page 14 for more kits



Fire Fountain Add-On Kit

Prepare to be amazed at the difference fire can make for your fountain. Ideal for use with Scalloped Urns.

#78260

Spillway Bowl, Basin, and Stand

D



	Spillway Bowl 19" Dia. (49 cm)	Spillway Basin 21" Dia. (52 cm)	Spillway Bowl Stand 6" H (15 cm)
Item Number	78422 78355	78423 78356	78425 78357
Dimensions	19"L x 19"W x 7.25"H	20.5L x 20.5W x 7"H	11"L x 11"W x 6"H
Primary Material	GFRC		
Finish	Iron Ore or Patina	Iron Ore or Patina	Iron Ore or Patina
Recommended Pump	Ultra 550 Water Pump #91006	Ultra 800 Water Pump #91007	—
Recommended Basin	AquaBasin 30 #78223		—
Packaged Weight	33.5 lb.	33.5 lb.	14.25 lb.



KIT AVAILABLE

Spillway Bowl and Basin Fountain Kit - Patina 19"/21" Dia (49/52 cm)

- Comes with AquaBasin® 30, pump, and plumbing

Packaged Weight: 113 lb. (51.5 kg)

Packaged Dimensions:
30"L x 30"W x 30"H

#78248

See Pages 13-14 for more kits



KIT AVAILABLE

Spillway Bowl and Basin Fountain Kit - Iron Ore 19"/21" Dia (49/52 cm)

- Comes with AquaBasin® 30, pump, and plumbing

Packaged Weight: 113 lb. (51.5 kg)

Packaged Dimensions:
30"L x 30"W x 30"H

#78427

See Pages 13-14 for more kits

K | F | P | A | L | P | A | W | T | S | C | F | P | C | D | L | U | G | P | P | I | T

Spillway Bowl, Basin, and Stand



	Spillway Bowl 32" Dia. (81 cm)	Spillway Basin 40" Dia. (102 cm)	Spillway Bowl Stand - each 4" H (10 cm) (2-pack)
Item Number	78420 78204	78421 78205	78424 78206
Dimensions	32"L x 32"W x 14.5"H	40"L x 40"W x 16"H	13.5"L x 13.5"W x 4"H
Primary Material	GFRC		
Finish	Iron Ore or Patina	Iron Ore or Patina	Iron Ore or Patina
Recommended Pump	Ultra 2000 Water Pump #91010		—
Recommended Basin	AquaBasin 45 #78224		—
Packaged Weight	70.25 lb.	119 lb.	33.5 lb.



KIT AVAILABLE

Spillway Bowl and Basin Fountain Kit - Patina 32"/40" Dia (81/102 cm)

- Come with AquaBasin® 45, pump and plumbing

Packaged Weight: 380 lb. (172 kg)

Packaged Dimensions:
40"L x 48"W x 66"H

[#58087](#)

[See Pages 13-14 for more kits](#)



KIT AVAILABLE

Spillway Bowl and Basin Fountain Kit - Iron Ore 32"/40" Dia (81/102 cm)

- Comes with AquaBasin® 45, pump, and plumbing

Packaged Weight: 380 lb. (172 kg)

Packaged Dimensions:
40"L x 48"W x 66"H

[#78426](#)

[See Pages 13-14 for more kits](#)

AquaGarden Mini Pond Kits

Item Number	Product	Color	Product Information
78325		Mocha	Packaged Weight: 19 lb. Dimensions: 23.5" Dia. x 9.875"H Packaged Dimensions: 24"L x 24"W x 14"H
78333		Gray	Packaged Weight: 19 lb. Dimensions: 23.5" Dia. x 9.875"H Packaged Dimensions: 24"L x 24"W x 14"H



AquaGarden Plant Light

- Low-voltage transformer included

Dimensions: 8"L x 3.75"W x 18.25"H
Packaged Dimensions: 20.5"L x 9"W x 4.25"H
Packaged Weight: 1 lb.
[#78332](#)



AquaGarden Stand

- Durable, powder coated iron construction

Dimensions: 13.25" Dia. x 16"H
Packaged Dimensions: 15"L x 14"W x 4.5"H
Packaged Weight: 1 lb.
[#78331](#)

AquaGarden Tabletop Fountain Kits

Item Number	Product	Color	Product Information
78346		Mocha	Packaged Weight: 5.25 lb. Dimensions: 11" Dia. x 5"H Packaged Dimensions: 12.2"L x 12.2"W x 6.3"H
78347		Gray	Packaged Weight: 5.25 lb. Dimensions: 11" Dia. x 5"H Packaged Dimensions: 12.2"L x 12.2"W x 6.3"H



D Fire and Water 3-Piece Basalt Torch System

Complete Kit

Includes everything to add torches to 3 columns



Fire and Water 3-Piece Basalt Torch System

- Recommended Pump: Ultra 2000 Water Pump #91010

Packaged Weight: 20 lb.

Packaged Dimensions: 18"L x 14"W x 14"H #58103

Customize your own installation using the a la carte components



	Fire and Water Basalt Column Torch	Match-Lit Flame Control System	Rubber Propane Gas Hose	4-Way 3/8" Splitter with Caps	Propane Tank Regulator and Hose – 3/8" x10'	
Item Number	58101	58102	58111	58112	58109	58104
Dimensions	9.5"H x 1.125"D	7.25"L x 7"W x 10"H	3/8" x 10'	3/8" x 20'	2.5"L x 2.5"W x .75"H	3/8" x 10'
Includes	Water tubing– 1/2" x 6' Rubber gas hose– 1/4" x 6' with 3/8" connection			—		
Packaged Weight	1 lb.	12 lb.	1.5 lb.	2.5 lb.	1 lb.	1.25 lb
Packaged Dimensions	10"L x 2"W x 2"H	15.75"L x 12"W x 10"H	10"L x 10"W x 2.5"H	12"L x 14"W x 2.5"H	3"L x 3"W x 1"H	8"L x 8"W x 3"H

Note: Fire and Water Torches not compatible with Faux Basalt Columns



Each Auto-Ignite Feature Includes:



Feature with Burner System



Flame Control System



Propane Tank Regulator



Gas Hose and Power Cable



Water Tubing



	Fire and Water Spillway Bowl	Fire and Water Spillway Basin
Item Number	58092	58116
Dimensions	34"L x 32"W x 15"H	40"L x 40"W x 16"H
Primary Material	Fiber-Resin Composite	
Includes	Fire and water feature, control system, gas tubing, power cable, water tubing, and propane tank regulator	
Recommended Pump	Ultra 2000 Water Pump #91010 (Sold Separately)	
Recommended Basin	AquaBasin 45 or custom using AquaBlox	
Packaged Weight	73 lb.	109 lb.
Packaged Dimensions	35"L x 35"W x 17.5"H	51"L x 42.5"W x 20"H



All auto-ignite fire features are CSA approved



Fire Media Sold Separately
See page 111

Auto-Ignite Fire Features



Fire Media
Sold Separately
[See page 111](#)



	Fire and Water Stacked Slate Sphere	Fire and Water Stacked Slate Urn
Item Number	58093	58114
Dimensions	32" Dia. x 24"H	35.5"L x 35.5"W x 55"H
Primary Material	Fiber-Resin Composite	
Includes	Fire and water feature, control system, gas tubing, power cable, water tubing, and propane tank regulator	
Recommended Pump	Ultra 2000 Water Pump #91010	
Recommended Basin	AquaBasin 45 or custom using AquaBlox	Custom using AquaBlox
Packaged Weight	127.75 lb.	203 lb.
Packaged Dimensions	35"L x 35"W x 21.75"H	38"L x 37.5"W x 34.6"H



All auto-ignite fire features are CSA approved



Fire Media
Sold Separately
[See page 111](#)



	Faux Stone Fire Pit
Item Number	58091
Dimensions	41.54"L x 34.25"W x 14.25"H
Primary Material	GFRC
Includes	Fire pit, control system, gas tubing, power cable, and propane tank
Packaged Weight	175.5 lb.
Packaged Dimensions	43.5"L x 35.5"W x 15.75"H



All auto-ignite fire features are CSA approved



**Mixed Tumbled
Lava Stones Shown**



**1/4" Reflective
Black Fire Glass Shown**

Black



Cobalt Blue



Aquamarine



Fire Media

	Medium Tumbled Lava Stones	Large Tumbled Lava Stones	Mixed Tumbled Lava Stones	1/4" Reflective Black Fire Glass	1/4" Reflective Cobalt Blue Glass	1/4" Aquamarine Fire Glass
Item Number	78316	78317	78318	78262	78263	78264
Packaged Weight	25 lb.		50 lb.	10.5 lb.		



Propane Tank Covers

	Faux Stone	Faux Stump	Stainless Steel Fire Pan Cover
Item Number	78336	78345	58115
Primary Material	GFRC	Fiber-Resin Composite	Stainless Steel
Dimensions	16.5"L x 16.5"W x 21.25"H	15"L x 15"W x 18"H	21.25" Dia. x 1.75"H
Packaged Weight	41.25 lb.	14 lb.	5.25 lb.
Packaged Dimensions	19.5"L x 19.5"W x 23.5"H	17.5"L x 17.5"W x 21"H	21"L x 24"W x 2.5"H

AquaBasin® underground reservoirs make it easy to install a variety of Aquascape water features

Pump Access

Large corner panel fits larger pumps and sits elevated to prevent gravel from falling into the basin

Deck Cylinders

Provide endless plumbing and lighting port configurations, while reinforcing basin strength

Drainage Slots

Located throughout the deck to maximize water circulation

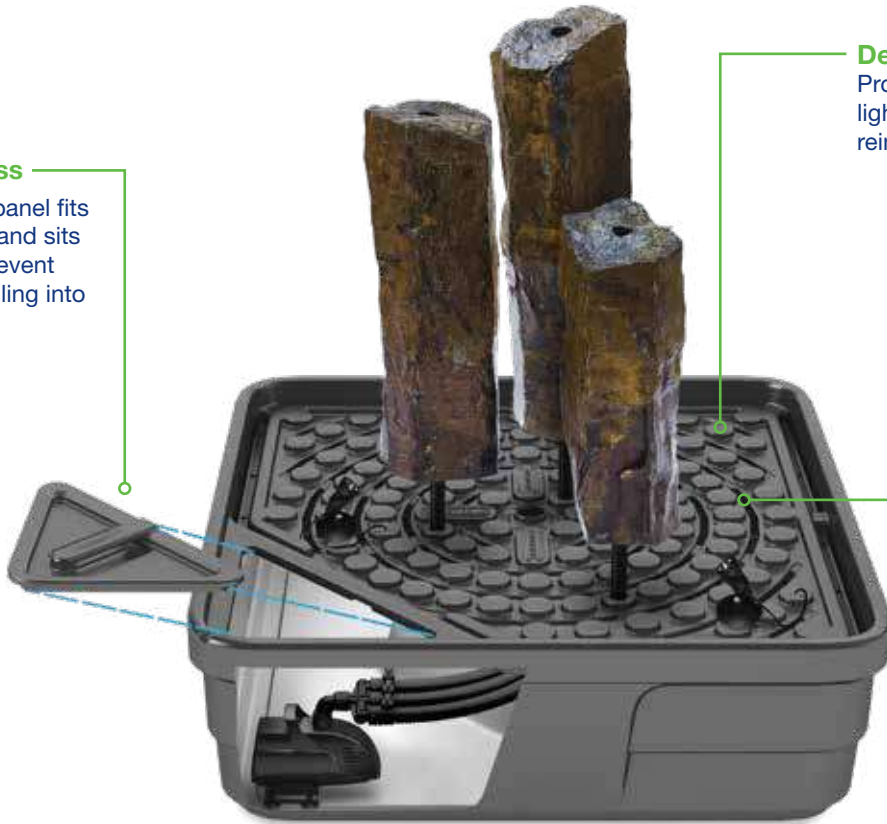

AquaBasin® 45 Shown



Water Feature Basins		
	AquaBasin® 30	AquaBasin® 45
Item Number	78223	78224
Dimensions	30"L x 30"W x 12"H	44.5"L x 44.5"W x 16"H
Water Storage Capacity	27 gal.	98 gal.
Maximum Flow Rate	2,000 GPH	4,000 GPH
Weight Capacity	500 lb.	1,500 lb.
Warranty	Limited Lifetime	
Packaged Weight	22 lb.	60 lb.



Natural Mongolian Basalt Columns

	24" H (61 cm)	30" H (76 cm)	36" H (91 cm)	Set of 3
Item Number	58038	98503	98969	58062
Dimensions	10" Dia. x 24"H	10" Dia. x 30"H	10" Dia. x 36"H	24", 30", & 36" x 10" Dia.
Included Tubing	—			
Recommended Pump	Ultra 800 Water Pump #91007			Ultra 2000 Water Pump #91010
Recommended Basin	AquaBasin 30 #78223	AquaBasin 45 #78224		
Packaged Weight	200 lb.	335 lb.	375 lb.	850 lb.



KIT AVAILABLE

Mongolian Basalt Columns Set of 3 Fountain Kit

- Comes with AquaBasin® 45, pump, and plumbing

Packaged Weight: 963 lb. (436.8 kg)

Packaged Dimensions: 40"L x 48"W x 31"H

#58089

[See Page 13 for more kits](#)



Faux Basalt Column Sets

Natural Stone Appearance
Molded from real stone for natural look and feel

Water Outlet
Recessed water outlet with included tubing and fitting for easy install

Lightweight and Durable
Handmade using fiberglass, resin, and real stone

Sturdy Base
Provides support to stabilize the fountain

Faux Basalt Columns - Set of 3 Shown



	Faux Basalt Columns - Set of 3 24", 30", 36" H (61, 76, 91 cm)	Faux Basalt Columns - Set of 5 18", 24", 30", 36", 42" H (46, 61, 76, 91, 106 cm)
Item Number	78367	78368
Primary Material	Fiber-Resin Composite	
Included Tubing	Corrugated PE Pipe- 3/4" (3)	Corrugated PE Pipe- 3/4" (5)
Recommended Pump	Ultra 2000 Water Pump #91010	AquaSurge 2000 Pond Pump #91017
Recommended Basin	AquaBasin 45 #78224	Custom using AquaBlox
Packaged Weight	52 lb.	86 lb.

Note: Faux Basalt Columns not compatible with Fire and Water Torches



KIT AVAILABLE

Faux Basalt Column Fountain Kit - 24" H (61 cm)

- Comes with the AquaBasin® 30, pump, and plumbing
- Packaged Weight: 35.5 lb. (16 kg)
- Packaged Dimensions: 30"L x 30"W x 20"H

#78251

See Page 13 for more kits



KIT AVAILABLE

Faux Basalt Columns Set of 3 Fountain Kit - 24", 30", 36" H (61, 76, 91 cm)

- Comes with the AquaBasin® 45, pump, and plumbing
- Packaged Weight: 185 lb. (84 kg)
- Packaged Dimensions: 40"L x 48"W x 31"H

#78366

See Page 13 for more kits



Faux Basalt Columns

Item Number	78361	78362	78363	78364	78365
Primary Material	Fiber-Resin Composite				
Includes Tubing	✓				
Recommended Pump	Ultra 400 Water Pump #91005		Ultra 800 Water Pump #91007		Ultra 1100 Water Pump #91008
Recommended Basin	AquaBasin 30 #78223 or DecoBasin #60000		AquaBasin 45 #78224 or custom using AquaBlox		
Packaged Weight	12 lb.	15 lb.	17 lb.	20 lb.	22 lb.

Note: Faux Basalt Columns not compatible with Fire and Water Torches





	Fairy Planter	Single Turtle on Log	Double Turtle on Log	Silly Snail	Jazz Frog
Item Number	78370	78371	78372	78373	78374
Dimensions	8.5"L x 12"W x 9.5"H	12"L x 6.5"W x 8"H	15.5"L x 6.25"W x 10"H	14.5"L x 7.5"W x 13.5"H	12.25"L x 13"W x 14.75"H
Included Tubing	1/2" ID x 48" (122 cm) Rubber Tubing				
Primary Material	Polystone				
Packaged Dimensions	17.1"L x 10.6"W x 15.7"H	10.6"L x 8.5"W x 14.4"H	17.9"L x 8.5"W x 12.6"H	17.1"L x 10.6"W x 15.7"H	15.4"L x 14.2"W x 16.9"H
Recommended Pump	90 GPH Water Pump #91024 (minimum)			180 GPH Water Pump #91025 (minimum)	
Packaged Weight	5.5 lb.	3.7 lb.	4.8 lb.	6.8 lb.	6.8 lb.



	Toucan	Naughty Dog	Lazy Frog on Lily Pad	Man in Barrel Spitter (barrel not included)
Item Number	78309	78310	78311	78315
Dimensions	15"L x 9"W x 16"H	17"L x 12"W x 12.75"H	12"L x 10"W x 5"H	37.5"L x 8"W x 12"H Head: 8.5"L x 11"W x 8"H Hand: 4.5"L x 5"W x 3"H
Included Tubing	1/2" ID x 48" (122 cm) Rubber Tubing	1/4" ID x 48" (122 cm) Rubber Tubing		
Primary Material	Polyresin			
Recommended Pump	90 GPH Water Pump #91024			
Packaged Weight	10.25 lb.	8.5 lb.	4.25 lb.	3.75 lb.
Packaged Dimensions	19"L x 12.5"W x 19.5"H	20.5"L x 12"W x 12.75"H	13"L x 12"W x 7.5"H	12"L x 9"W x 14.5"H



	Deer Scarer	Pouring 3-Tier	Adjustable Pouring
Item Number	78306	78307	78308
Dimensions	5.5"L x 4"W x 14"H	5"L x 3.25"W x 15.5"H	18-30"L x 4.5"W x 10"H
Included Tubing	1/4" ID x 48" (122 cm) Rubber Tubing		
Primary Material	Polyresin		
Packaged Dimensions	18"L x 7"W x 8"H	18.5"L x 7.25"W x 7.5"H	22.25"L x 7.5"W x 9"H
Recommended Pump	90 GPH Water Pump #91024		
Packaged Weight	4.25 lb.	3.25 lb.	5.75 lb.



NEW



	Fountain Cover Sphere 18" Dia. (46 cm)	Fountain Cover Sphere 24" Dia. (61 cm)	Fountain Cover Sphere 32" Dia. (81 cm)	Fountain Cover Sphere 40" Dia (102 cm)
Item Number	78431	78375	78376	78377
Dimensions	19" x 19" x 14.25" H	25"L x 25"W x 21.5"H	33"L x 33"W x 28"H	41"L x 41"W x 35"H
Primary Material	900 Denier, 18 oz. PVC coated polyester			
Packaged Weight	2 lb.	2.6 lb.	3.2 lb.	4.25 lb.
Packaged Dimensions	10" L x 9" W x 2" H	13.5"L x 8.25"W x 3.25"H		13.5"L x 8.25"W x 4"H

NEW



	Fountain Cover Urn 24" H (61 cm)	Fountain Cover Urn 32" H (81 cm)	Fountain Cover Urn 45" H (114 cm)	Fountain Cover Urn 56" H (142 cm)
Item Number	78430	78378	78379	78380
Dimensions	16"L x 16"W x 22"	22"L x 22"W x 32"H	30"L x 30"W x 44"H	36.5"L x 36.5"W x 54.5"H
Primary Material	900 Denier, 18 oz. PVC coated polyester			
Packaged Weight	2 lb.	2.5 lb.	3.9 lb.	5.7 lb.
Packaged Dimensions	10" L x 9" W x 2" H	13.5"L x 8.25"W x 3.25"H		13.5"L x 8.25"W x 4"H



NEW

NEW



	Fountain Cover Spillway Bowl 19" Dia. (48 cm)	Fountain Cover Spillway Basin 21" Dia. (53 cm)	Fountain Cover Spillway Bowl 32" Dia. (81 cm)	Fountain Cover Spillway Basin 40" Dia. (102 cm)
Item Number	78432	78433	78381	78382
Dimensions	20"L x 20"W x 5.25"H	21.5"L x 21.5"W x 5"H	34"L x 34"W x 14"H	41"L x 41"W x 15.5"H
Primary Material	900 Denier, 18 oz. PVC coated polyester			
Packaged Weight	1.75 lb.	1.75 lb.	2.5 lb.	3.2 lb.
Packaged Dimensions	10"L x 9"W x 2"H	10"L x 9"W x 2"H	13.5"L x 8.25"W x 3.25"H	13.5"L x 8.25 W x 3.25 H

NEW FOR ALL SIZES OF FOUNTAIN BOWLS



	Fountain Cover Square 27" (68 cm)	Fountain Cover Square 33" (84 cm)	Fountain Cover Bowl 32" Dia. (81 cm)	Fountain Cover Bowl 40" Dia. (102 cm)	Fountain Cover Bowl 50" Dia. (127 cm)	Fountain Cover Bowl 60" Dia. (152 cm)
Item Number	78438	78439	78434	78435	78436	78437
Dimensions	28" sq. x 12"H	34" sq. x 14"H	33" Dia. x 12"H	41" Dia. x 14"H	51" Dia. x 18"H	61" Dia. x 20"H
Primary Material	900 Denier, 18 oz. PVC coated polyester					
Packaged Weight	2.5 lb.	2.5 lb.	2.5 lb.	3.2 lb.	4 lb.	5 lb
Packaged Dimensions	13.5"L x 10"W x 3.25"H			13.5"L x 10"W x 4"H	13.5"L x 10"W x 4.5"H	13.5"L x 10"W x 4.75"H

K | F | P | A | L | PA | WT | SC | FPC | D | LUG | PP | IT

Decorative Accessories



	Faux Driftwood 30"	Faux Driftwood 35"	Faux Log Fish Cave	Faux Rock Fish Cave - Small	Faux Rock Fish Cave - Large
Item Number	78276	78277	78324	78418	78419
Features	Ideal for concealing hard-to-hide water feature components, such as skimmers and spillways		Provides pond fish shelter from predators	25"L x 15"W x 9.5"H	30"L x 18"W x 11"H
Primary Material	Polyresin			Fiber-Resin Composite	
Dimensions	30"L x 4"W x 4"H	35"L x 4"W x 5"H	19"L x 12"W x 10"H	25"L x 15"W x 9.5"H	30"L x 18"W x 11"H
Packaged Weight	4.5 lb.	7.5 lb.	11.5 lb.	10.5 lb. (4.7 kg)	14 lb. (6.3 kg)
Packaged Dimensions	31.75"L x 7"W x 10.5"H	36"L x 8"W x 10.75"H	22"L x 15"W x 13"H	25.25"L x 18.25"W x 12.25"H	32"L x 20.5"W x 15"H



	Faux Oak Stump Cover	Faux Rock Cover - Small	Faux Rock Cover - Large
Item Number	78259	78416	78417
Features	Great for hiding outdoor electrical outlets, power cords and transformers		
Primary Material	Polyresin	Fiber-Resin Composite	
Dimensions	15" Dia. x 18.5"H	25"L x 15"W x 9.5"H	30"L x 18"W x 11"H
Packaged Weight	19 lb.	10.5 lb.	14 lb.
Packaged Dimensions	18"L x 18"W x 21"H	25.25"L x 18.25"W x 12.25"H	32"L x 20.5"W x 15"H



	Fountain Shims (set of 6)	Tumbled Lava Stones	Decorative River Pebbles-Black	Decorative River Pebbles-Mixed
Item Number	78159	78316 78317 78318	78160	78161
Features	Ideal for leveling resin, concrete, stone, or GFRC water fountains	Attractive accent to your water feature		
Dimensions	4.25"L x 1"W x 7"H	Medium Large Mixed	3" to 5"	
Surface Coverage	—	1.5 sq. ft.		
Packaged Weight	.5 lb.	25 lb. 25 lb. 50 lb.	22 lb.	
Packaged Dimensions	4"L x 1"W x 7"H	—	9"L x 3.5"W x 14"H	

Liner, Underlayment, and Geotextile

Aquascape offers a wide variety of liner, underlayment, and geotextiles to provide a solid foundation for your water feature.



1 Rock Pad

Extra-thick, non-woven polypropylene fabric provides a significant cushion between the liner and large rocks, effectively protecting the liner from rips or tears

2 Woven Microgrid Geotextile

Provides a long-lasting barrier to prevent rock and debris from entering sub-surface water reservoirs while allowing water to easily infiltrate the storage basin

3 EPDM Pond Liner

The ideal membrane for retaining water in ponds, Pondless® Waterfalls, and other water features

4 Non-Woven Geotextile Underlayment

Used to protect pond and water feature liner from rocks, roots, and other sharp objects that may damage the liner

5 Concrete Canvas®

Flexible cement-impregnated fabric that hardens upon hydration to form a durable concrete layer, protecting liner from digging animals, human traffic, or damage from setting large rocks or boulders

Liner, underlayment, and geotextile are the pond's foundation. With a large selection of liners available, it is important make sure the liner you choose is safe for fish that may inhabit the pond.



Fish Safe 45 mil EPDM Liner Rolls

Item Number	Roll Dimensions	Packaged Weight
42002	5' x 100'	164 lb.
29188	10' x 50'	164 lb.
29189	10' x 100'	324 lb.
29192	15' x 50'	243 lb.
29193	15' x 100'	486 lb.
29196	20' x 50'	324 lb.
29197	20' x 100'	648 lb.
29200	25' x 50'	402 lb.
29201	25' x 100'	810 lb.
29202	30' x 50'	486 lb.
29203	30' x 100'	972 lb.
29206	40' x 50'	678 lb.
29207	40' x 100'	1,295 lb.
29210	50' x 50'	810 lb.
29211	50' x 100'	1,635 lb.

Fish Safe 45 mil EPDM Boxed Liner

Item Number	Liner Dimensions	Packaged Dimensions	Packaged Weight
85009	8' x 10'	12"L x 12"W x 12"H	26 lb.
29607	10' x 10'	20"L x 15.5"W x 9.5"H	33 lb.
85000	10' x 12'	16"L x 11"W x 14.5"H	39 lb.
29612	10' x 20'	20"L x 16"W x 13"H	65 lb.
29616	10' x 30'	17.5"L x 24"W x 14"H	98 lb.
85001	12' x 15'	18"L x 11.5"W x 14.5"H	59 lb.
85002	15' x 15'	20"L x 25.5"W x 15"H	74 lb.
85003	15' x 20'	19"L x 17"W x 19"H	98 lb.
85004	20' x 25'	21"L x 18"W x 22"H	164 lb.

Don't see the liner type or size that you need here?

We have many other liner options available including 150' & 200' lengths of 45 mil EPDM, and up to 200' rolls of 60 mil EPDM. We also have custom sizes of Reinforced Polyethylene (RPE) and Linear Low-Density Polyethylene (LLDPE) liners in multiple thicknesses.

NEW

EPDM Surface Prep

- Professional grade cleaner formulated to remove dirt, dust, surface oils, and talc from liner
- Ensures maximum primer and seam tape adhesion
- Improves seam strength and durability
- Quick flash-off to keep projects moving



NEW

EPDM Tape Primer Plus

- Exceptional bonding power ensures a durable, long-lasting connection between EPDM surfaces and seaming tapes
- Smooth, uniform coverage applies evenly to create a consistent bonding surface
- Enhanced weather resistance supports strong adhesion even in challenging environmental conditions



	EPDM Surface Prep	EPDM Tape Primer Plus
Item Number	54021	54022
Packaged Weight	1 Qt. (.946 liters)	1 Qt. (.946 liters)



	EPDM Tape Primer	QuickSeam Pond Liner Repair Kit
Item Number	54008	42023
Kit Includes	—	6" x 6" QuickSeam patches, bottle of LVOC primer (2 oz. / 57 ml), scrubber pad, patch roller, pair of disposable gloves
Packaged Weight	2 lb.	.5 lb.



	EPDM Liner Patch	EPDM Liner One-Sided Cover Tape 12" x 25' (30.5 cm x 7.6 m)	EPDM Liner One-Sided Cover Tape 6" x 25' / 6" x 100'	EPDM Liner Double-Sided Seam Tape 3" x 25' / 3" x 100'
Item Number	22018	42161	22003 22005	22017 22020
Packaged Weight	.25 lb.	13 lb.	6.25 lb. 20 lb.	2 lb. 20 lb.



Compact Rolled Underlayment			
Item Number	Grade	Liner Dimensions	Packaged Weight
42147	Heavy-Duty	15' x 50' Compact Roll	44 lb.
42148	Heavy-Duty	15' x 100' Compact Roll	82.25 lb.

Precut Underlayment			
Item Number	Grade	Liner Dimensions	Packaged Weight
42135	Heavy-Duty	5' x 10'	2.7 lb.
42136	Heavy-Duty	7.5' x 7.5'	2.8 lb.
42137	Heavy-Duty	8' x 10'	3.2 lb.
42138	Heavy-Duty	10' x 10'	3.5 lb.
42139	Heavy-Duty	10' x 12'	3.9 lb.
42140	Heavy-Duty	10' x 15'	4.4 lb.
42141	Heavy-Duty	10' x 20'	5.25 lb.
42142	Heavy-Duty	12' x 15'	5 lb.
42149	Heavy-Duty	15' x 15'	6 lb.
42143	Heavy-Duty	15' x 20'	7 lb.
42144	Heavy-Duty	15' x 25'	8.25 lb.



Rolled Underlayment			
Item Number	Grade	Liner Dimensions	Packaged Weight
42154	Heavy-Duty	15' x 300'	212 lb.
42157	Standard	5' x 300'	62 lb.
42156	Standard	7.5' x 300'	81 lb.
42155	Standard	15' x 300'	201 lb.



	Heavy-Duty Rock Pad Sling 10-Pack	Rock Pad 3.28' x 98.43' Roll	Rock Pad 15' x 150' Roll
Item Number	42088	42073	25001
Packaged Weight	20 lb.	37.5 lb.	260 lb.



	Woven Microgrid Geotextile 8' x 270' Roll	Woven Microgrid Geotextile 4' x 4'	Concrete Canvas® Roll 3.375' x 30'
Item Number	42016	42015	85026
Packaged Weight	65 lb.	.5 lb.	141 lb.

 Only Available for Sale in the USA



K | F | P | A | L | P | A | W | T | S | C | F | P | C | D | LUG | P | P | I | T

Pipe and Plumbing



Pipe



Check Valve



Water Fill Valve



Complete your water feature with high quality plumbing products. Whether you're starting a new project, or updating an existing water feature, you can trust Aquascape to provide what you need to get the job done right.



High-Quality Pipe

Has the durability to be glued into standard schedule 40 PVC fittings

Flexible PVC Pipe		
Item Number	Pipe Dimensions	Packaged Weight
48015	1" x 50'	14.5 lb.
29021	1.5" x 25'	13 lb.
29022	1.5" x 50'	24 lb.
29023	2" x 25'	14 lb.
29024	2" x 50'	30.75 lb.
29025	3" x 50'	31 lb.
29026	3" x 100'	118 lb.



Extremely Flexible

Resistant to crimping or collapsing around tight curves

Kink-Free Pipe		
Item Number	Pipe Dimensions	Packaged Weight
98288	1/2" x 100'	9.25 lb.
94002	3/4" x 25'	3.5 lb.
94003	3/4" x 100'	17.75 lb.
94001	1" x 25'	4 lb.
94004	1" x 100'	16.75 lb.
94000	1.25" x 25'	6 lb.
94005	1.25" x 100'	23 lb.
94006	1.5" x 25'	5.75 lb.
94007	1.5" x 100'	38.5 lb.



Ideal for Recirculating Water

No need for PVC glue

Black Vinyl Tubing		
Item Number	Pipe Dimensions	Packaged Weight
94008	3/8" x 100'	7 lb.
94009	1/2" x 100'	6 lb.
94010	3/4" x 50'	11.75 lb.



Flexible and Crush Proof

Great for fountain applications, this pipe is made to last. It will not kink, crush, or split.

Corrugated PE Pipe		
Item Number	Pipe Dimensions	Packaged Weight
88070	3/4" x 6' (1.83 m)	0.6 lb.
88071	3/4" x 7' (2.13 m)	0.7 lb.
88072	3/4" x 50' (15.24 m)	5.4 lb.
88074	3/4" x 15' (4.57 m)	1.6 lb.

(PE = Polyethylene)

Check Valves and Plumbing Accessories

Heavy-Duty Flapper
Ensures longevity



Angled, Swing-Style Valve
Effectively prevents back flow

Dual-Union Connections
Simplifies pump and filter maintenance

Dual Union Check Valve 2.0 Shown



	Dual Union Check Valve 2.0	Dual Union 3" Check Valve	Check Valve Adapter for EcoWave® Pond Pump - 2"
Item Number	48026	29098	88058
Packaged Weight	3.75 lb.	7.5 lb.	.5 lb.
Packaged Dimensions	14"L x 9"W x 4.75"H	24"L x 9"W x 9"H	3.75"L x 3.75"W x 4"H

Visit our website <https://www.aquascapeinc.com/product-category/pipe-plumbing/valves-fittings> and choose from a large variety of fittings and valves designed to fit all your plumbing needs.



	Compact Water Fill Valve	Water Fill Valve 200	Hudson Water Fill Valve
Item Number	88006	29272	29469
Features	Small size fits in any skimmer, Pondless® Waterfall Vault, or AquaBasin.	Reliable mechanical arm-style fill valve. Brass hardware with poly float.	Mounting plate allows for 4-inch setting adjustments. Use Fill Valve Irrigation Conversion Kit (#01008) to connect to 1/2" PVC.
GPM	Up to 1.5 gal.	Up to 3 gal.	Up to 1.5 gal.
PSI	0-100		8-65
Fittings	1/4", 1/2" poly-pipe, 1/2" pvc pipe (pipe sold separately)	1/2" poly-pipe, 1/2" pvc pipe (pipe sold separately)	Quick-connect for 1/4" poly-pipe (pipe sold separately)
Packaged Weight	.75 lb.	1 lb.	1.25 lb.

K | F | P | A | L | PA | WT | SC | FPC | D | LUG | PP | IT



	Dual Union 3" Check Valve	Low Suction Intake Attachment	2-Way Flow Control Valve	Christy's Red Hot Blue Glue
Item Number	29098	91117	88005	29969
Packaged Weight	7.5 lb.	.5 lb.	1.5 lb.	.4 lb.
Packaged Dimensions	24"L x 9"W x 9"H	5.75"L x 4.5"W x 5.75"H	9"L x 4.5"W x 8"H	-

Visit our website <https://www.aquascapeinc.com/product-category/pipe-plumbing/valves-fittings> and choose from a large variety of fittings and valves designed to fit all your plumbing needs.



	Fill Valve Spigot 1/4" Quick-Connect	Garden Hose Adapter Assembly	Fill Valve Irrigation Conversion Kit	WFV Poly Pipe Roll 1/4" x 100' / 1/2" x 100'
Item Number	07000	29517	01008	29350 29470
Connection	1/4" poly pipe to garden spigot	1/2" poly pipe to garden spigot	-	-
Conversion	-	-	1/4" Hudson Water Fill Valve up to 1/2" poly pipe or PVC	-
Packaged Weight	.25 lb.	.05 lb.	.05 lb.	1.25 lb. 5 lb.

EXT Pump 2"-3" Plumbing Kit

- Includes fittings, flanges, valves, and hardware to install the EXT pump at the perimeter of the pond's edge.

Packaged Weight: 21 lb.

Packaged Dimensions: 12.5"L x 12.5"W x 12"H

#48027

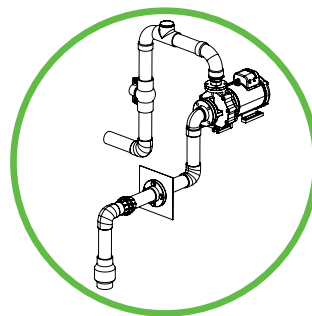

EXT Pump 3" Plumbing Kit

- Includes fittings, flanges, valves, and hardware to install the EXT pump at the perimeter of the pond's edge.

Packaged Weight: 25 lb.

Packaged Dimensions: 12.5"L x 12.5"W x 12"H

#48044

Installation Tools



Foam



Gun



Silicone



Whether you are a do-it-yourselfer or professional water feature contractor, Aquascape has all the pieces and parts you need for successful water feature installation or repair.

Refer to Liner Section [page 123](#) for Liner Seam, Cover Tape, Primer and Patch Kits



	Pond and Waterfall Foam Sealant	Professional Black Waterfall Foam	Professional Foam Gun Cleaner	Waterfall Foam Gun Applicator
Item Number	82002	30096	22011	54003
Application	Applicator straw included. No Foam Gun required	Foam Gun Applicator required	Cleans Foam Gun Applicator	Use with item #30096 & #22011
Packaged Weight	1 lb.	2 lb.	1.25 lb.	1.5 lb.



	Installation Kit	Black Silicone Sealant 4.7 oz / 10.1 oz	Clear Silicone Sealant 10.1 oz	Christy's Red Hot Blue Glue
Item Number	22008	22010 29186	82000	29969
Application	Applicator straw included No Foam Gun required	Used for sealing joints where liner attaches to BioFalls® lip and skimmer faceplate. Fish safe.		.4 lb.
Packaged Weight	2.25 lb.	.5 lb.	.75 lb.	-



Inspiration & Education

Learn more about water features and Living the Aquascape Lifestyle®



Shop on Our Website



Follow Us on Facebook



Watch Us on YouTube



Follow Us on Instagram



Get Inspired on Pinterest



Pondside E-Newsletter



Aquascape Lifestyles E-Magazine



Greg Wittstock, The Pond Guy



TEAM Aquascape



Ed The Pond Professor



901 Aqualand Way • St. Charles, IL 60174
Toll Free: (866) US-PONDS or (866) 877-6637
support.aquascapeinc.com
Email: emails@aquascapeinc.com

1200 Creditstone Rd., Unit 1
Concord, Ontario L4K 5T2
Toll Free: (866) 766-3426
Email: customerservicecanada@aquascapeinc.com